

February / février 2007 Volume/volume 101 Number/numéro 1 [722]

# Journal

The Journal of the Royal Astronomical Society of Canada    Le Journal de la Société royale d'astronomie du Canada



## INSIDE THIS ISSUE

Assessing a MOP to Cleanly Sweep Astronomical Images  
Is the Famous Nova of Hipparchus (134 BC) Depicted on a Judaeon Coin?  
Where is the Radiant? • DSLR Astrophotography, Part II

CELEBRATING 100 YEARS OF PUBLICATION

# contents

table des matières

## FEATURE ARTICLES/ARTICLES DE FOND

### 6 Assessing a MOP to Cleanly Sweep Astronomical Images

by Rob Lerner, Nicholas Mikhail, Ian Shelton, and Martin Connors

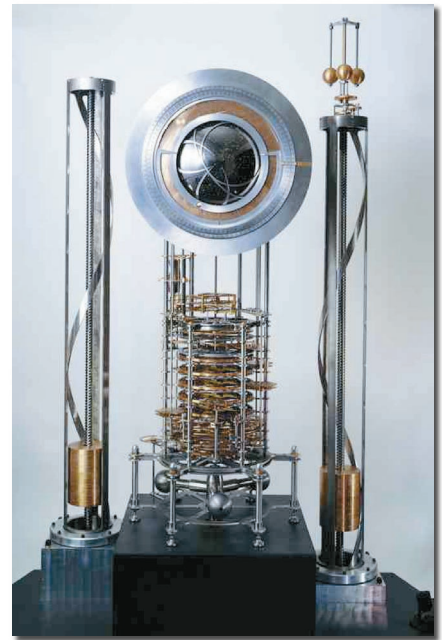

News Notes  
p. 4

### 11 Is the Famous Nova of Hipparchus (134 BC) Depicted on a Judaeen Coin?

by Jean-Philippe Fontanille



Judaeen Coin  
p. 11

### 14 Where is the Radiant?

by Jeremy B. Tatum

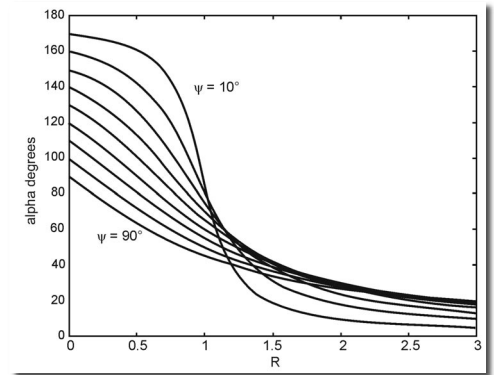

Where is the Radiant?  
p.14

### 25 DSLR Astrophotography, Part II

by Doug George

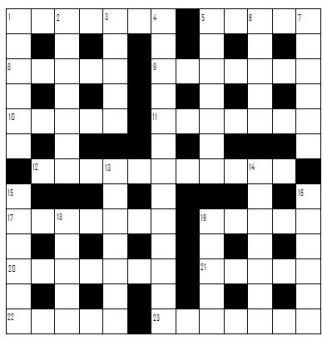

Astrocryptic  
p. 44

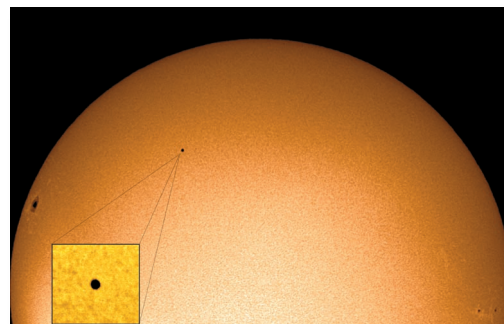

Great Images: Transit of Mercury  
p. 39



A Moment With...Dr. Alexander Jones  
p. 33

DEPARTMENTS/DÉPARTEMENTS

**2 President's Corner**

*by Scott Young*

**3 Editorial**

*by Jay Anderson*

**4 News Notes/En manchettes**

*The Clock of the Long Now — A Reflection*  
*by Martin Beech*

**41 Reviews/Critiques**

*The Cosmic Century: A History of Astrophysics and  
Cosmology; Solar System Observer's Guide*

ACROSS THE RASC  
DU NOUVEAU DANS LES CENTRES

**40 Calgary Centre Invites RASC Members to  
General Assembly & Astronomy Roundup  
2007**

*Astronomy Roundup Organizing Committee*

**44 Astrocryptic**

*by Curt Nason*

Cover: M 13

This image of the great globular cluster in Hercules was obtained at Flesherton, Ontario, August 12, 2006 by Stuart Heggie with a ST-10XME CCD Camera using a Takahashi FSQ scope and Astrodon RGB filter set. Each RGB channel was imaged  $6 \times 10$  minutes, self guided on an AP900QMD mount. Images acquired and darks & flats applied in CCDSoft v5.0; aligned and combined in MaxIm DL; colour channels assembled in Adobe Photoshop CS2. Levels, curves, some sharpening and noise reduction in Adobe Photoshop CS2; Subtractive Chromatic Noise Reduction (SCNR) from PixInsight LE.

COLUMNS/RUBRIQUES

**26 Second Light: What is a Planet?**

*by Leslie J. Sage*

**27 Deep-Sky Contemplations: Hubble's Variable  
Nebula**

*by Warren Finlay and Doug Hube*

**29 Through My Eyepiece: Starting Out: Buying  
a Telescope**

*by Geoff Gaherty*

**31 Gizmos: Rings and Things**

*by Don Van Akker*

**33 A Moment With...Dr. Alexander Jones**

*by Philip Mozel*

**35 Carpe Umbram: A Tale of Three Asteroids**

*by Guy Nason*

**39 Great Images: Transit of Mercury**

*by Les Marcz*



# President's Corner

by Scott Young (sdy@mts.net)

One of the greatest things about the RASC as a national organization is that you meet people from all across the country. My day job involves quite a bit of travel, and it always seems to happen near the dark of the Moon. Through the RASC I've made friends in most major cities in Canada, so whenever I'm in a different city I can find out where the local astronomy club meets and who might be observing that night. I've been able to get out under a clear sky in almost any city I've visited, all due to my friends in the RASC. Sure beats HBO in the hotel room!

Many of these people come together once a year at the RASC's General Assembly. This year's GA is hosted by the Calgary Centre, and is a joint meeting of the RASC, the American Association of Variable Star Observers (AAVSO), and the Association of Lunar and Planetary Observers (ALPO). If you've never been to the GA, consider it as a vacation destination this year. Sure, there is the National Council meeting that is spoken of with good-natured dread by those who attend it — but there are also talks, displays, and programs on all aspects of this hobby. It's a great boost to see all the great projects that go on across the RASC, and I always come home with a new enthusiasm for observing, new gear I want to buy, and new projects to tackle. This year's grouping with the AAVSO and ALPO promises to make a good thing even better. The 2007 GA will be held June 28 through July 1 in Calgary; check out <http://calgary.rasc.ca/ar2007/index.htm> for details.

Clear skies,  
Scott

# Journal

The *Journal* is a bi-monthly publication of the Royal Astronomical Society of Canada and is devoted to the advancement of astronomy and allied sciences. It contains articles on Canadian astronomers and current activities of the RASC and its Centres, research and review papers by professional and amateur astronomers, and articles of a historical, biographical, or educational nature of general interest to the astronomical community. All contributions are welcome, but the editors reserve the right to edit material prior to publication. Research papers are reviewed prior to publication, and professional astronomers with institutional affiliations are asked to pay publication charges of \$100 per page. Such charges are waived for RASC members who do not have access to professional funds as well as for solicited articles. Manuscripts and other submitted material may be in English or French, and should be sent to the Editor-in-Chief.

#### Editor-in-Chief

Jay Anderson  
136 Dupont St  
Toronto ON M5R 1V2, Canada  
Internet: editor@rasc.ca  
Web site: www.rasc.ca  
Telephone: (416) 924-7973  
Fax: (416) 924-2911

#### Associate Editor, Research

Douglas Hube  
Internet: dhube@phys.ualberta.ca

#### Associate Editor, General

Michael Attas  
Internet: attasm@aegl.ca

#### Assistant Editors

Michael Allen  
Martin Beech  
Pierre Boulos  
Ralph Chou  
Daniel Hudon  
Patrick Kelly

#### Editorial Assistant

Suzanne E. Moreau  
Internet: semore@sympatico.ca

#### Production Manager

James Edgar  
Internet: jamesedgar@sasktel.net

#### Contributing Editors

Martin Beech (News Notes)  
Warren Finlay (Deep-Sky Contemplations)  
Christopher Fleming (Skies Over Canada)  
Geoff Gaherty (Through My Eyepiece)  
Doug Hube (Deep-Sky Contemplations)  
Richard Huziak (Variable Stars)  
Paul Langan (Net Astronomy)  
Bruce McCurdy (Orbital Oddities)  
Philip Mozel (A Moment With...)  
Guy Nason (Carpe Umbram)  
Leslie Sage (Second Light)  
Russ Sampson (News Notes)  
David Turner (Reviews)  
Don Van Akker (Gizmos)

#### Proofreaders

James Edgar  
Terry Leeder  
Maureen Okun  
Suzanne Moreau

#### Design/Production

Brian G. Segal, Redgull Incorporated

#### Advertising

James Edgar  
Internet: jamesedgar@sasktel.net

#### Printing

Maritime Digital Colour

The *Journal of The Royal Astronomical Society of Canada* is published at an annual subscription rate of \$80.00 by The Royal Astronomical Society of Canada. Membership, which includes the publications (for personal use), is open to anyone interested in astronomy. Annual fees for 2007: Youth, \$34.25; Ordinary, \$55.00; Life Membership, \$2,100. Applications for subscriptions to the *Journal* or membership in the RASC, and information on how to acquire back issues of the *Journal* can be obtained from:

The Royal Astronomical Society of Canada  
136 Dupont St  
Toronto ON M5R 1V2, Canada  
Internet: nationaloffice@rasc.ca  
Web site: www.rasc.ca  
Telephone: (416) 924-7973  
Fax: (416) 924-2911

Canadian Publications Mail Registration No. 09818  
Canada Post: Send address changes to 136 Dupont St, Toronto ON M5R 1V2  
Canada Post Publication Agreement No. 40069313

We acknowledge the financial support of the Government of Canada, through the Publications Assistance Program (PAP), toward our mailing costs.

U.S. POSTMASTER: Send address changes to IMS of NY, PO Box 1518, Champlain NY 12919.  
U.S. Periodicals Registration Number 010-751.  
Periodicals postage paid at Champlain NY and additional mailing offices.

© 2007 The Royal Astronomical Society of Canada. All rights reserved. ISSN 0035-872X

# Editorial

by Jay Anderson ([jander@cc.umanitoba.ca](mailto:jander@cc.umanitoba.ca))

Christmas is now on the doorstep as I write this column, and James Edgar, bless his pointy head, is about to receive the entire download of this issue later today. Knowing James, he'll work on it through the season and have it ready to go before the New Year. I hope Mrs. Edgar will forgive me, and him.

The Boxing Day flyers are on the kitchen table, advertising the usual deals. One is a really neat telescope — you know, a 60-mm refractor (700-mm focal length) that reaches 526 power. With 12.5- and 25-mm eyepieces, a 3× Barlow, and a 1.5× image erector. Gang them all up and lo and behold, you have a magnification of 526 (wait a minute...526?). Just the telescope for our President (it's a Winnipeg Centre joke).

The question is: where is the RASC in all of this? Why is this country's premier astronomy organization not making a fuss about the false or misleading advertising that permeates the Christmas season when it comes to things astronomical? For that matter, why is the RASC so invisible in the media and the public arena at any time?

Most of us enjoy the night sky on an individual or small-group basis. For the most part we are casual about winter observing, about participation in public outings, and easy-going about our hobby. However, we understand the night, the stars, the special events, from ISS and shuttle passes to comets and eclipses; we note in quiet satisfaction the anti-crepuscular rays from a setting Sun that point to a rising Full Moon, knowing that our fellow citizens are completely oblivious of the terrestrial and astronomical alignments that make it possible. In a sense, we are the modern extension of those Babylonian sky-watchers who kept track of the comings and goings of the night — we are the insiders, the priests, the gurus of our times. We are the

members of this semi-secret society known as the RASC.

Alas, we have become irrelevant in our modern Internet society with its YouTube visual clips and seconds-long sound bites. In our pursuit of individual satisfaction, we have stopped being a national force. The ancient scribes influenced the King, but we cannot influence the advertising that goes into a flyer. We cheapened out.

Money is the root of it. We have become obsessed with the cost of our Society, scrimping and cutting until our finances limit our influence and our ability to provide even for our own membership. We have become a 60-mm refractor.

In a big widespread national organization, fiscal responsibility is critical. Fiscal responsibility doesn't necessarily mean low prices — it can also mean a good deal on high prices. For our governors, that means selling a vision that members are willing to fund, perhaps in spite of a substantial increase in the tariff. Think of what the RASC could be: weekly press releases about the sky, media commentators on TV and radio, our calendars in every bookstore with our *Handbook* on the shelves. We could cooperate with the Australians on observing programs. We could deliver prominent speakers to the Centres. We could publish — observing handbooks, astrophoto handbooks, Internet news services, how-to booklets, CDs, and DVDs — and probably recover our costs if we could only afford the seed. Heck, we might even give the printed copy of the *Journal* back. The ongoing mantra is that we would lose members, but there is an equal chance that a more prominent RASC just might get it all back. It's time to step out of the box.

To join the British Astronomical Association (on which the RASC is modelled) will cost you \$88.38 Canadian this week. Perhaps that is where we should be. ●

## ARE YOU MOVING? IS YOUR ADDRESS INCORRECT?

If you are planning to move, or your address is incorrect on the label of your *Journal*, please contact the National Office immediately:

(888) 924-7272 (in Canada)  
(416) 924-7973 (outside Canada)  
email: [nationaloffice@rasc.ca](mailto:nationaloffice@rasc.ca)



By changing your address in advance, you will continue to receive all issues of *SkyNews* and the *Observer's Handbook*.

# The Clock of the Long Now — A Reflection

by Martin Beech, Regina Centre ([beechm@uregina.ca](mailto:beechm@uregina.ca))

Sandwiched between the past and the future we all live in the “now”: it is our fate. Indeed, the act of looking to the past or of contemplating the future requires a conscious displacement from the all-embracing “now” in which we live. A somewhat cynical interpretation of human history tells us that collectively we learn very little from past mistakes: wars are repeated and finite resources continue to be run down and exhausted. What about predicting the future? Here, once again, our record is not much better. Just like astrologers, so-called futurists make myriad predictions, some of which, mostly by pure chance, come true; I suppose that even a stopped clock is right twice a day! Is it a waste of time, therefore, to study history and contemplate the future? “Most definitely not!” is the clear answer, but we should certainly take more notice of both the past and the future in the “now” of our collective lives.

We cannot change the past, but we can change the future, and Greek mythology provides us with the story of *Tithonus* to reflect upon when we attempt to contemplate the possible world to be. *Tithonus*, the story goes, was gifted with eternal life by Zeus but underhandedly cursed by not being granted perpetual youth. At “the quiet limit of the world”<sup>1</sup> *Tithonus* withered and decayed — alive but entirely impotent. Here is the message for our contemplation. In our short sound bite, 15 minutes of dubious glory, rapidly changing, downloaded and uplinked world, we run the risk of becoming impotent and isolated, just like *Tithonus*, in a perpetual “now” devoid of direction and future relevance. Indeed, as founding Long Now Project member Stewart Brand<sup>2</sup> puts it, “Civilization is revving itself into a pathologically short attention span.” If our collective thinking continues in the vein of self-serving immediate gratification, then we truly have no future, because we will fail to realize that there is one. This is exactly why the Long Now Project is such a wonderful idea.

The essential aim of the Long Now Project is to forge an appreciation for the future by linking it to the past through an active involvement in the continuous and expansive “now.” The clock of the Long Now, the resplendent prototype of which can be seen in the Science Museum in London (Figure 1), was the first physical production of the Long Now Project. It ticks once per year, but uses digital sequencing for precision. The clock is refreshingly non-electronic in construction; it requires maintenance and “winding,” and its parts will need to be periodically replaced by attendant keepers. The point of the clock is entirely about

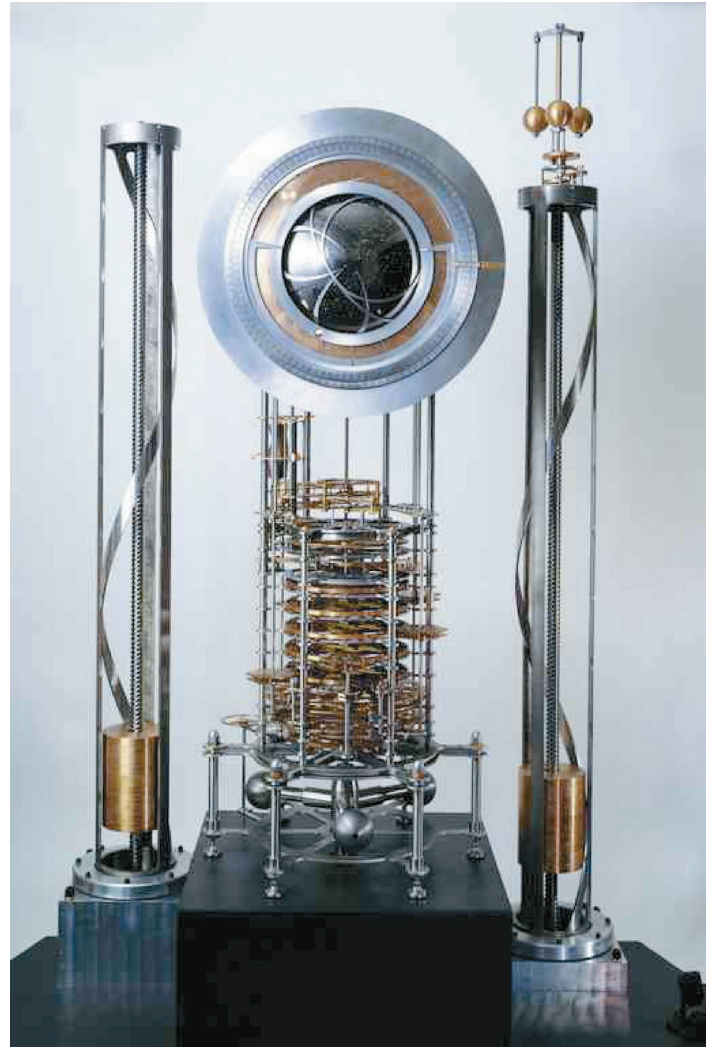

Figure 1 — The Clock of the Long Now. The two outer columns contain the drive weights that power the clock, while the central column contains the binary mechanical computer (lower part) and the dial face (upper part). The dial shows the year as a five-digit number, as well as the sky locations of the Sun, Moon, and brighter stars. (Image from [www.longnow.org/shop/free-downloads](http://www.longnow.org/shop/free-downloads)).

stewardship and accepting the responsibility of transferring something tangible from our “now” to our distant descendants’ “now.”

The design of the clock is based upon five key principles: *longevity*, *maintainability*, *transparency*, *evolvability*, and *scaleability*. These design concepts allow, in principle, for the

clock to be kept running by almost any culture that is capable of making gear plates, cams, and levers. The design also allows for the system to evolve, to be improved upon, and copied — the stewards of the clock are not just mindless keepers of their heritage.

Inherent to the daily functioning of the Long Now Clock is an automatic noontime Sun-correction feature. It will not drift in its projected 10,000-year lifetime with respect to solar time. Here, the heartbeat of ancient astronomy is preserved, the clock and our daily lives all governed and synchronized by celestial motion. Indeed, the dial face of the clock shows a rotating star field, sidereal time, and the 26,000-year precession cycle of the equinoxes.

The very first “tick” of the prototype Long Now Clock was struck at midnight, December 31, 1999. It then started the third millennium with two rings of its one-thousand-year chime. The mechanical clock has been with humanity since the early 14th Century<sup>3</sup>, and the resonant “tock” of the pendulum-driven anchor and escapement wheel, so sadly missing from modern-day quartz-driven devices, has become a potent sound bite for the passage of time. Equally potent with respect to the symbolism of passing time and the stately movement of the heavens is the mechanical orrery<sup>4</sup>, the first such devices appearing in the early 18th century. The Long Now Project, conscious of the Platonic notion that the planets are the embodiment of a universal clock, recently revealed its own homage to the orrery (Figure 2). It is a superb and humbling machine, beautifully crafted and infused with precision<sup>5</sup>. Made primarily of Monel® and stainless steel, the orrery towers eight feet from top to bottom and while it “ticks” once every 12 hours, the locations of the planets historically visible to the human eye (Mercury through to Saturn) are calculated to 28-bit accuracy. Incredible!

The Long Now Orrery and the Long Now Clock are beautiful machines and a glowing testament to human skill and ingenuity. They deserve to be examined, thought about, and contemplated in a slow, conscious, and reflective manner. What is perhaps most inspiring about these machines, however, is that they are linked to the heavens — the ultimate timekeeper. Ten thousand years from now, when our world and its many troubles will have been long forgotten, our descendents will still have the familiar symbols of the sky to guide them in their contemplations. I hope that the Long Now Clock and Orrery will also be with them — to link their distant “now” with ours. ●



Figure 2 — The Long Now Orrery. Standing some eight feet tall, the orrery displays the relative positions of the planets Mercury through to Saturn. This image is just one of the 125 photographs taken of the orrery by Jake Appelbaum at its recent unveiling. The other images can be viewed at [www.longnow.org/projects/clock/orrery](http://www.longnow.org/projects/clock/orrery).

*Martin Beech teaches astronomy at Campion College, the University of Regina.*

#### Notes and References:

1. Alfred Lord Tennyson expresses the grief of *Tithonus* in his evocative poem of the same name. See <http://tennysonpoetry.home.att.net/tith.htm>.
2. From the essay by Stewart Brand: [www.longnow.org/about](http://www.longnow.org/about).
3. The origins of the mechanical clock are very nicely discussed in John North’s recent book *God’s Clock Maker*, Hambleton Continuum, 2004.
4. The name orrery originated from the Sun-Earth-Moon machine built by John Rowley in 1713 for Charles Boyle, 4th Earl of Cork and Orrery, Ireland.
5. The design and workings of the orrery are described in an article by Brad Lemley published in *Discovery Magazine* **26** (11), 2005. The article can also be accessed from the orrery Web page: [www.longnow.org/projects/clock/orrery](http://www.longnow.org/projects/clock/orrery).

#### WEB ACCESS TO THE 2007 ISSUES OF THE JRASC

The 2007 issues of the *Journal* can be accessed from the RASC Web site at [www.rasc.ca/currentjrasc](http://www.rasc.ca/currentjrasc). Issues are posted immediately after the final production version is complete.

## Assessing a MOP to Cleanly Sweep Astronomical Images

ROB LERNER<sup>1</sup>, NICHOLAS MIKHAIL<sup>2</sup>, IAN SHELTON<sup>3</sup>, MARTIN CONNORS<sup>4</sup>

1 3 4 Athabasca University, 1 University Drive, Athabasca AB T9S 3A3

<sup>1</sup> lerner@ualberta.ca

<sup>2</sup> nmikhail@dal.ca

<sup>3</sup> ians@athabascau.ca

<sup>4</sup> martinc@athabascau.ca

**ABSTRACT:** Current research at Athabasca University involves the search for both Earth Trojans and near-Earth objects (NEOs), and requires a suitably flexible moving-object detection package. This software must have the ability to detect moving objects in both Canada-France-Hawaii Telescope (CFHT) images and images taken with our Athabasca University Robotic Telescope (AURT). The AURT will capture images comparable to the best professional images of 20 years ago, a level that serious amateur astronomers can now attain. CFHT remains at the cutting edge of astronomical instrumentation, thus reducing its images is a demanding task. For these reasons, flexibility has been an important consideration in selecting software. We have assessed the Moving Object Detection Pipeline (MOP) from Petit *et al.* (2004) using both CFHT's Very Wide Legacy Survey (CFHTLS-VW) images and images taken from the Athabasca University Geophysical Observatory (AUGO). Results show that although mosaic images will yield some missed detections, the MOP will be an asset in finding moving objects in both CFHTLS-VW and AURT images. The processing of the latter images would be of substantial interest to amateur astronomers interested in conducting useful science.

**RÉSUMÉ.** Un projet entrepris à l'université d'Athabasca concerne la recherche d'objets troyens et autres objets orbitant près de la Terre. Cette recherche demande un logiciel de détection suffisamment flexible pour déceler des objets en mouvement. Le logiciel doit avoir la capacité de déceler dans des images captées par le télescope Canada-France-Hawaii (CFHT) ainsi que dans celles par le télescope robotisé de l'université d'Athabasca (AURT) les objets qui se déplacent dans le ciel. Le AURT pourra produire des images comparables au meilleur images professionnelles d'il y a 20 ans, un niveau que l'astronome amateur sérieux peut maintenant atteindre. Le CFHT demeure au-devant de l'instrumentation astronomique et donc, la réduction de ses images est une tâche exigeante. Pour cette raison, la flexibilité est une considération importante dans le choix du logiciel. Nous avons évalué Moving Object Detection Pipeline (MOP) de Petit *et al.* (2004) en utilisant les images du CFHT - Very Wide Legacy Survey (CFHTLS-VW) et celles de l'Observatoire géophysique de l'université d'Athabasca (AUGO). Les résultats de cette évaluation indique que, quoique des images mosaïques produisent des détections qui auraient été manquées, le MOP sera un atout pour retrouver les objets qui bougent dans les images captées par le CFHTLS-VW et le AURT. Le traitement des images de ce dernier surtout aurait un intérêt particulier pour les astronomes amateurs qui s'intéressent à mener des projets scientifiques utiles.

### Introduction

While the 3.6-m CFHT is no longer among the world's top ten largest telescopes, its capabilities are enhanced with advanced instrumentation. The combination of aperture and field of view it now has with the MegaPrime / MegaCam system puts CFHT at the forefront of astronomical imaging. The MegaCam detector consists of 36 CCDs mosaiced to give a field of view of 0.96 by 0.94 degrees. This detector is the largest astronomical CCD mosaic ever built. Each CCD is  $2048 \times 4612$  pixels with a resolution of 0.187 arcseconds per pixel, for an effective size of 18,432 by 18,448 pixels (~340 megapixels). There are other mosaic CCDs used for astronomical imaging such as the Kitt Peak National Observatory's mosaic

with a 0.6 by 0.6 degree field of view. Similar advances in instrumentation allow even small telescopes to do important research (Paczynski 2006). An example is the AURT, which will operate under very dark skies, remotely, in Athabasca, Alberta. Of only 0.4 metre aperture, it will have a Starlight Xpress SXV-M25 camera, which we have tested (see below) and will give a field of view of 0.45 by 0.67 degrees. The 2000 by 3000 pixel CCD array gives colour images typically containing thousands of objects. A common feature of both large and small telescopes with a modern detector is the generation of a large amount of digital data. In the case especially of searches for moving objects, automation of detection is a necessity.

The CFHT's new capabilities make it an ideal modern survey instrument and a set of "legacy surveys" has been



undertaken. The CFHTLS-VW was designed to discover and accurately determine orbits for a large, unbiased sample of Trans-Neptunian Objects (TNOs) populating the Kuiper Belt in the outskirts of our solar system at 30-50 AU (Trujillo, Jewitt, & Luu 2001). The survey covered most of the ecliptic in three colors down to approximately 24th magnitude. The detection phase of the survey involved obtaining three images spaced by approximately one hour at locations along the ecliptic when at opposition.

The publicly available MOP was evaluated by Petit *et al.* (2004) specifically for its ability to detect TNOs in the CFHTLS-VW data (see acknowledgments for the download Web site). A significant problem with most moving-object detection packages, especially when looking for faint objects, is the large number of false detections. Petit *et al.* drastically reduced these false detections by independently running two separate detection packages and matching their common output. They used *Sextractor* (Bertin & Arnouts 1996) and a wavelet method to find all objects in the individual frames. *Sextractor* uses elevated pixel counts in contrast to the local background to identify objects. In contrast, the wavelet method produces a spectrum in wavelet space, in which the scale upon which features vary can be characterized. This scale is set by the seeing and other factors, and can be used to identify real objects. The two algorithms, having unrelated noise characteristics, give slightly different object lists. Objects common to both lists are very likely to be real and not false detections. In the MOP, offsets between the images are determined by using the brighter peaks (stars) from the wavelet method in the field. Once aligned, the lists of intensity peaks are scanned for all objects that did not appear, or were potentially not in the same position, in all three frames. These “potential moving objects” are grouped into all possible combinations of three, using one object from each frame to test for linear motion proportional to the time between images. The MOP also tests for a maximum deviation in flux, elongation, and size. Objects that pass all the tests are output as moving-object candidates and checked by the operator.

Although the Very Wide Legacy Survey was designed to study TNOs, its deep, nearly one-square-degree images are well populated with much closer, and therefore faster moving, objects. We assessed the Petit *et al.* software for its effectiveness in detecting all moving bodies (not just TNOs) within CFHTLS-VW fields, and have begun preliminary testing of the MOP with images taken from the AUGO.

We have found that the MOP are able to detect moving objects in both CFHTLS-VW and AUGO images. The MOP's ability to process the latter, which is similar to those from advanced amateur systems, will be of interest to amateur astronomers wishing to do useful science.

## Evaluation Procedure

The Legacy Survey images were generated using the CFHT's MegaPrime / MegaCam with its mosaic detector composed of

36 CCDs arranged in a  $9 \times 4$  array. All CFHT images used in our tests were obtained from the Canadian Astronomical Data Centre (CADC), which manages the processing, archiving, and distribution of CFHTLS-VW images to users (<http://cadwww.dao.nrc.ca>). The images are pre-processed (Elixir-ed) at CFHT, involving bias and dark subtraction, flat-fielding, and fringe subtraction. The CADC then sends these images to be processed by TERAPIX in Paris, France (Radovich *et al.* 2001).

We examined two different CFHTLS-VW positions. For field “2490m014” we used G-band (487nm with a bandwidth of 145nm) filtered exposures numbered (CHFT “odometer”) 793200p, 793216p, and 793233p. For field “1322p004,” G-band exposures numbered 780241p, 780279p, 780303p, and I-band (770nm with a bandwidth of 145nm) exposures numbered 788676p, 788685p, and 788695p were used.

For each field's 3 like-filtered exposures, the 36 component images making up each exposure were unpacked using CFITSIO into sub-directories indexed by CCD number (Pence 1999). The MOP is then run on each of the component image sets. Certain command-line options can be specified to give the user control over both the maximum and minimum step size needed for an object to be considered moving, as well as the slope at which the object can move with respect to a user-defined angle. Other parameters, including the allowable ratio of maximum to minimum of flux, elongation, and size, can be changed in the source code. These options filter out a substantial number of objects and aid in the detection of very specific motions. The default settings are oriented to finding TNOs, which are outer Solar System bodies with relatively slow on-sky motion. With a maximum step size of 6 arcseconds ( $\sim 32$  pixels) per hour and angular width of 40 degrees, the MOP's default is perfect for finding these objects. For our trial, we increased the maximum step size to 200 arcseconds ( $\sim 1070$  pixels) per hour and allowed all orientations for the motion. These settings allow for detection of the nearer, hence faster moving, main-belt asteroids. Moving-object candidates output by the software were manually verified using SAOImage (DS9) (Joye & Mandel 2003) by aligning the three images with the built-in World Coordinate System (WCS) coordinates supplied by the CADC, and blinking the image triplets. The visually verified moving objects were then checked against the Jet Propulsion Laboratory's (JPL) Solar System Dynamics — DASTCOM database, HORIZONS, under the small-body database (see acknowledgments). This database gives the option of listing all small bodies for a given time, observing location, and field of view.

## Test Results

Over all test runs, the number of objects detected and verified was from two to five times greater than the number predicted to be within the field using HORIZONS. This discrepancy indicates that there are a significant number of Solar System bodies yet to be discovered. The combination of a wide field of view and

a magnitude limit in the mid-twenties makes CFHT / MegaCam, as used in the legacy survey, a workhorse for such discovery. However, many of the objects predicted to be within the field were not actually detected. The cause for this was investigated and summarized in Table 1.

## Discussion

As outlined in Table 1, some of the JPL-catalogued small bodies were missed by the MOP. After close inspection of each missed object's expected position within the fields, it became clear that there are several reasons why mosaic images will always lead to missed detections with this software.

First of all, the MOP demands that moving objects appear in all three frames. Thus, if a moving object falls in a gap between the chips, it will not be output as a candidate. In CFHT MegaCam images, the small gaps between CCDs are  $\sim 13$  arcseconds (70 pixels) and the two larger gaps between CCD rows are  $\sim 80$  arcseconds (425 pixels) (Figures 1 and 2). These gaps account for  $\sim 8\%$  of the entire field of view. Using this value, we can predict the approximate percentage of objects expected to be missing due to the dead space in the requisite three exposures. From the dead space alone on three consecutive images, we get  $\sim 24\%$ . This number will be a lower bound as it is based on the MOP being able to detect an object that is less than half lost in a gap. From our 3 test sets of mosaic images, we see a loss of 15 objects (30%) not detected due to the gaps. Two of these objects were touching a gap (Figure 2). Noting that the CFHTLS-VW was designed to find slow-moving TNOs, not fast-moving main-belt asteroids, the loss of TNOs to the gaps would be closer to the 8% value because the motion of these objects is much smaller.

Secondly, the MOP can only examine each chip individually, meaning that if an object walks between chips, the software will miss it. To attempt to overcome this limitation, we experimented with sets of nine chips patched together, but found that, among other complications, the computation time was prohibitively long to be of any real use.

Mosaic problems are not the only reasons for missed detections. Every CCD has inherent imperfections, or "dead pixels." The CFHT MegaCam Web site gives a value of  $\sim 0.2\%$  for the number of dead pixels over the entire mosaic. Although not a huge contributor to missed detections, we still found that two objects (4%) went undetected due to this problem. When checking the predicted positions of objects expected to be in the field but not found, these two objects were seen to be obstructed by columns of dead pixels. We found that even if an object is just touching a defective column, the MOP cannot detect it as moving. One possible explanation is that when a column of dead pixels passes through an object, it may cause the MOP to detect it as two separate objects. One object was missed due to masking by a diffraction spike and charge overflow produced by a bright star. But the MOP can also be tricked into finding many false detections in the vicinity of such artefacts

TABLE 1: DETECTED VERSUS PREDICTED MOVING OBJECTS

Series	780	788	793	Total
<b>Candidates</b>	91	150	125	366
<b>Verified objects</b>	49	112	110	271
<b>JPL expected objects</b>	27	59	23	109
<b>JPL objects found</b>	10	33	16	59
<b>JPL objects missed</b>	17	26	7	50
<b>Reasons undetected</b>				
<b>In a gap</b>	5	9	1	15
<b>Walked b/w chips</b>	6	1	0	7
<b>Dead pixels</b>	0	2	0	2
<b>Diffraction spikes of star</b>	0	1	0	1
<b>Not there</b>	5	12	6	23
<b>Should have found it</b>	1	1	0	2

Caption: The verified objects are those candidates output by the MOP and visually verified using DS9. The JPL expected objects are those given by the JPL Horizons database for an observer at Mauna Kea for the time and field of view of the CFHTLS-VW exposure. The JPL objects found correspond to the objects that match the ones found by the MOP.

(see Figure 1).

The biggest contributor to our list of "undetected" objects, though, appears to be simply because many of the HORIZONS objects were far from where they were predicted to be. This result is frustrating because we wanted to test the MOP by comparing its detections against as many known objects as



Figure 1 — This image is an approximately 3x4-arcminute view of the sky ( $\sim 0.4\%$  of the entire mosaic). The white space in the middle is one of the small vertical gaps between chips ( $\sim 13$  arcseconds). In the top highlighted box is a moving object made evident by superimposing three frames on one image. It was missed by the MOP due to masking by a diffraction spike from the bright star. The middle of the three objects (indicated by the arrow) is clearly difficult to detect, even by eye. In the bottom rectangle, highlighted by black boxes, are the coordinates of a false detection by the MOP. These positions appear to coincide with rays from the bright star.

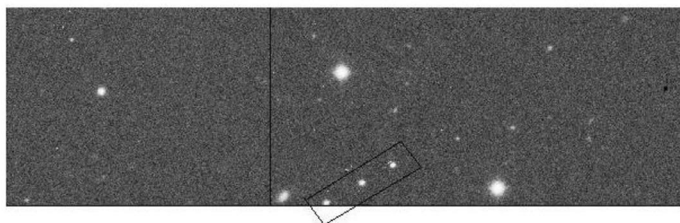

Figure 2 — This image is an approximately 3x4-arcminute view (same scale as Figure 1). On the top chip, centre, is a moving object missed by the MOP because it is touching a gap in the chips. On both chips, dead pixel columns (vertical black lines) can be seen. The gap here is one of the large horizontal ones between chip rows (~80 arcseconds).

possible. The precision of the ephemerides on the JPL site is indicated by a quality code. This code is a number ranging from 0 to 9, with zero being the best. The quality-code formula takes into account the orbital period and its uncertainty, the eccentricity, and the uncertainty in the time of perihelion of the object. This means that the higher the quality number for an object, the greater the uncertainty in its orbit and the larger the error ellipse for its position. In all cases where expected objects were not found, the quality code was either no better than three or undefined. Some of these objects could have been beyond the mosaic's field of view; and perhaps many of the "newly discovered" moving objects found by the MOP are in fact these known objects with poorly determined orbits.

The last table entry in Table 1 is the "should have found it" row. If we accept the shortcomings of the MOP with respect to mosaic images (gaps and walking between chips), and the technological shortcomings of all CCD cameras (size, dead pixels, and diffraction spikes), we are left with two (4%) of all possible objects left undetected. As mentioned above, the MOP utilizes two detection algorithms and matches the common output. The final two missed objects were clearly seen when one manually blinks through the images, and are in fact found as potential moving objects by the *Sextractor* algorithm. The wavelet method also found these two objects, but failed to accept them as moving objects.

As seen in Table 1, there is a fluctuation in the false detection rate between the different image sets. We define detection accuracy as the number of objects verified by the operator divided by the number of candidates output by the MOP. The 780 series has a 54% detection accuracy (49/91), while the 788 and 793 series have accuracies of 75% (112/150) and 88% (110/125) respectively. One possible explanation for this discrepancy is the time steps between exposures. The 788 and 793 series have steps of approximately 40

minutes, while the 780 series has an average time step of nearly 88 minutes. The MOP looks for linear motion with user defined maximum and minimum settings. An increase in the time between exposures, while keeping the maximum step size constant, vastly expands the area in image space the MOP is allowed to look for matches from a seed object. This expanded area gives a greater chance for a noise source to be misdetected as an object. It is therefore consistent that the number of false detections should increase with an increased time between exposures.

Since the MOP was originally designed to be used with CFHTLS-VW images, we expected it to work smoothly with that data. As seen above, with some losses due to looking for main-belt objects instead of the originally intended TNOs, this was found to be the case. Our own observatory camera and reduction software are quite different from those used to generate the CFHT images. Therefore, it would be a real demonstration of the MOP's utility if it was found equally effective in processing our own images. Preliminary testing of the pipeline using AUGO images looks promising.

As we were waiting the completion of the AURT, we decided to obtain test images using a Pentax camera lens (55-mm focal length, stopped down to f/3.5) attached to our CCD camera. Several 10-minute exposures were taken at approximately a 24-hour interval. The camera was mounted to a polar-aligned 10-inch Meade LX200 Schmidt-Cassegrain telescope to provide sidereal tracking and to test our camera and telescope control software. The Starlight Xpress SXV-M25 camera uses a Sony CCD with integral Bayer filter-mask designed to generate colour images from single exposures. This particular CCD camera is very inexpensive compared to cameras incorporating similar size "science-grade" monochrome CCDs.

We anticipate that with an expected seeing of ~2 arcseconds and a plate-scale of 0.8 arcseconds per RAW pixel, stellar images generated by the AURT should adequately sample the 2x2 pixel colour rasters on the CCD to permit accurate astrometry with adequate photometric precision. The size of stars seen in our test images using the camera lens was found to adequately sample the CCD's colour raster. Dark frames and twilight flat-field exposures were obtained and applied before the colour information was synthesized using the program *MaxIm DL* (Cyanogen Software). The colour images were then converted into grey-scale images before analysis with the MOP. Our test images had visual limiting magnitudes of between 14.7 and 15. The MOP was able to detect bodies B and C of Comet 73P/Schwassmann-Wachmann and asteroid 354 Eleonora moving within the large field-of-view (16 by 24 degree) test images (Figure 3). The magnitude of the asteroid varied between 10.0 and 10.9. The comet had magnitudes between 10.4 and 10.7 for body B, and between 9.9 and 12.2 for body C.

We conclude that the MOP can be used effectively both with large field images from the SXV-M25 camera, as well as with the CFHTLS-VW images for which it was originally designed. The vast difference between these images, in turn, suggests that serious amateurs could use the MOP to detect moving objects in their own images, regardless of telescope or CCD. We anticipate

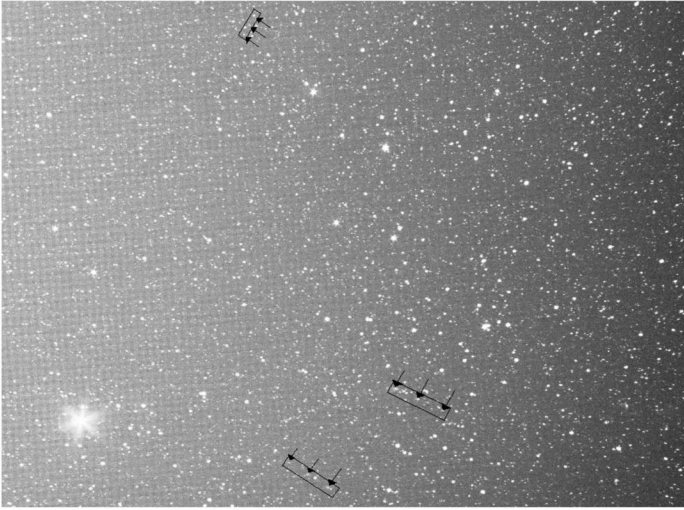

Figure 3 — This image is a ten-minute exposure taken with a 35-mm lens attached to our Starlight Xpress CCD camera. The field of view is approximately 8x10 degrees. The bright star (bottom left) is Arcturus. Highlighted in the top rectangle is the motion of asteroid 354 Eleonora. The middle and bottom rectangles are bodies B and C of Comet 73P/Schwassmann-Wachmann. All motion is seen by superimposing the three positions onto one image. The original images were taken at comparable times on the nights of April 2, 3, and 4, 2006.

using the MOP when AURT is fully operational with the SXV-M25 at the Newtonian focus of our 0.4-metre (14-inch) automated telescope.

### Technical Issues

We have identified some technical or operational issues relating to the use of the MOP and briefly describe them here. The part of the MOP that reads the header of the FITS files needs to find the detector (camera) name in order to extract relevant information. As there are no universal guidelines for “FITS” keywords, the MOP uses a program called `create_header.f` to obtain this information. For CFHT MegaCam images, this program works as supplied in the MOP package. We made some additions to the `create_header.f` program file to make our observatory output readable. These additions include converting the date and time from the given dd-mm-yyyy and hh:mm:ss to Julian date, and calculating the pixel scale from the given pixel size and focal length.

Also, the MOP homepage states that the MOP has been tested on some Redhat distributions and should work on most Linux systems. After considerable effort, the MOP is finally installable on Fedora Core 4 (FC4). Surprisingly, the same debugging that permitted the MOP to run on FC4 does not work for either FC3 or FC5. Personal experience suggests that using a Linux platform that already supports the MOP is better than porting the MOP to another version (as we did). The MOP utilizes FORTRAN, C, and shell code throughout, including advanced features that vary slightly among versions of Linux.

Another issue standing in the way of readily using the MOP is the amount of documentation. Along with limited

comments throughout the source code, the user is only told the order in which to invoke commands. This lack of information becomes a problem when trying to understand why certain objects are detected, while other obvious ones are not. Mapping out the MOP through its various subroutines has allowed us easy tracking of its global variables. We are willing to pass this information along to others.

### Conclusion

Testing of the MOP with CFHTLS-VW and AUGO images has shown that this software can detect moving objects in vastly different image sets. Some objects will always be missed when using the CFHT mosaic images, but these losses will not affect our single CCD AURT images as much. If we accept these losses, we are left with a very capable software package that is well suited to our needs. The pending completion of the AURT will allow for further testing and we anticipate that use of our SXV-M25 camera with our 0.4-metre telescope, instead of simply with a lens, will cause only minimal complications.

### Acknowledgments

The MOP software is freely available from [www.obs-besancon.fr/publi/petit/Preprints/detection.html](http://www.obs-besancon.fr/publi/petit/Preprints/detection.html). This paper is based on observations obtained with MegaPrime / MegaCam, a joint project of CFHT and CEA/DAPNIA, at the Canada-France-Hawaii Telescope (CFHT), which is operated by the National Research Council (NRC) of Canada, the Institut National des Sciences de l’Univers of the Centre National de la Recherche Scientifique (CNRS) of France, and the University of Hawaii. We compared our “found objects” against those predicted by JPL’s HORIZONS Database for small bodies found at <http://ssd.jpl.nasa.gov/sbfind.cgi#results>. We thank the Canadian Astronomy Data Centre, operated by the Dominion Astrophysical Observatory for the National Research Council of Canada’s Herzberg Institute of Astrophysics, for the processing of the CFHT images. Thanks also to Dr. P.A. Shelton (Winnipeg, Manitoba) for providing the 10-inch Meade telescope, and Margaret Anderson of Athabasca University for the 35-mm camera lens used for our test images. We have also benefited from discussions with Paul Wiegert, Christian Veillet, and Brett Gladman in implementing our asteroid search program. ●

### References

- Bertin, E. & Arnouts, S. 2006, A&AS, 117, 393
- Joye, W.A. & Mandel, E. 2003, ASP Conference Series, Vol. 295
- Paczynski, B. 2006, AAS Meeting 208, #1.01
- Pence, W.D. 1999, ASP Conference Series, Vol. 172
- Petit, J.-M., Holman, M., Scholl, H., Kavelaars, J., & Gladman, B. 2004, MNRAS, 347, 471
- Radovich, M. *et al.* 2001, ASP Conference Series, Vol. 232
- Trujillo, C.A., Jewitt, D., & Luu, J.X. 2001, AJ, 122, 457

# Is the Famous Nova of Hipparchus (134 BC) Depicted on a Judaean Coin?

by Jean-Philippe Fontanille ([jp.fontanille@sympatico.ca](mailto:jp.fontanille@sympatico.ca))

**ABSTRACT:** An unlisted and fascinating coin of Judaeen King Hyrcanus I may well depict the nova observed by Hipparchus in 134 BC, and thus constitute the oldest known illustration of an astronomical event.

**RÉSUMÉ:** Une fascinante monnaie non répertoriée du roi de Judée Hyrcan 1er pourrait bien représenter la nova observée par Hipparque en l'an 134 av. J.-C. et constituer ainsi la plus ancienne illustration d'un événement astronomique.

## Introduction

In Book II, Chapter XVI of his encyclopaedia *Naturalis Historia*, Pliny the Elder (AD 23-79) reports that the greatest astronomer of antiquity, Hipparchus of Nicaea (190-120 BC), “discovered a new star that was different from the comets and was produced in his own age.” This event took place in 134 BC, when Hipparchus was in Rhodes. So struck was he by this phenomenon that it incited him to create a catalogue of 1080 stars, embodied 2 centuries later in the *Almagest*, the monumental astronomical work of Ptolemy (AD 85-165). It was the first time in history that the phenomenon now called a nova and well known by present-day astronomers, was recorded. If this phenomenon was clearly visible in Rhodes, there is no doubt that it was also visible in Judaea.

## The Coin with the Star

In October 2006, as I was checking for new coins appearing on the market for other numismatic research, I was amazed to discover an unlisted coin of King John Hyrcanus I on the online store of a dealer (Fig. 1). John Hyrcanus I (135-104 BC) was a king of the Hasmonean dynasty (167-37 BC). He was also the first Jewish ruler to issue coins. The obverse of this 1.44-gram bronze coin bears the normal inscription for coins of this type: “Yehohanan the High Priest and the Council of the Jews” in paleo-Hebrew, inside a laurel wreath. However, the reverse depicts an unexpected but well-drawn star above the usual pomegranate framed by a double cornucopia (Fig. 2). The double cornucopia was an agricultural symbol of plenty, inspired by Greek culture, and the pomegranate was a typically Jewish symbol of fertility. In his description the dealer noted: “Unpublished variant with star above pomegranate.” The description proved correct, as an exhaustive search confirmed that this variety was definitely missing from the main reference works published on the subject (Kaufman 2004; Meshorer 2001; Kaufmann 1995; Meshorer 1982). Another detail was striking: the double cornucopia and the pomegranate are more crudely cut than usual. I will



Figure 1: The unlisted coin of Hyrcanus I showing a star on the reverse.

comment later on this important fact.

As a long-time aficionado of astronomy, I sensed that this unique coin might be an item of tremendous importance, not only for numismatics but for the history of science as well. Could this star possibly be the nova observed by Hipparchus?

It goes without saying that a Judaeen engraver would never have taken it upon himself to place an alien object within the official patterns unless he had a serious reason to do so. Moreover, in Judaea, illustrations were strictly controlled due to the numerous religious prohibitions of the time (Fontanille 2006). The Second Commandment explicitly forbids graven images,



Figure 2: Six reverses of coins struck under Hyrcanus I for comparison. The lower coin is the subject of this article.

which makes Judaeen coins quite different from those of other nations. For example, human or animal representations were strictly prohibited, and it was also deemed improper to depict exactly the cultic objects used in the Temple of Jerusalem (Kaufman 2004). In one sense, the illustrations on Judaeen coins were probably more planned and controlled than in any other nation, especially before the Roman occupation that began in 63 BC. If this extremely rare coin depicts an object that is unexpected and exceptional compared to the other coins struck under this king, it must be related to an event that was also unexpected and exceptional.

### Why is this Coin so Rare?

The die with the star can be seen as a variety of the massively struck, and thus very common, coin type listed as “Group E” by Prof. Y. Meshorer (2001 - see group E in plates 12 to 15). Also, it has been established that such common coin types — hundreds of thousands of coins minted — were not struck in one production run, but “as need arose” throughout the reign of a king or at least part of it (Ariel 2000). By this, I mean that this die may have been cut “live” during those days of summer 134 BC when the phenomenon was quite visible and before the brightness of this new star started to gradually diminish until it became invisible again, forever. It is not at all a “commemorative” coin as would be, three centuries later, the Bithynian bronze coins depicting Hipparchus and a globe. The die with the star may have been cut a few days after the nova appeared in the sky of Judaea, as a spectacular, exceptional, and symbolic event, only to “disappear” from the following dies just as it had disappeared from the sky. If this coin of Hyrcanus is so rare, it may well be because the nova of Hipparchus was in effect visible for only a short period. After it disappeared, there was no reason to maintain it on the dies.

### A Die Cut Early on During Hyrcanus’ Reign

The coins of Hyrcanus are all undated, but several important details seem to indicate that the die depicting the star was cut at the very beginning of his reign, which would make it coeval with the apparition of the nova.

As can be observed on Fig. 2, the die depicting the star is cruder and less harmonious than the other ones (the double cornucopia is rough and squared, and the pomegranate is too big with too short a stem). This is a good indication that this die was cut at the very beginning of Hyrcanus’ reign, when the nature of the patterns (double cornucopia and pomegranate) had already been planned, but their shapes were not yet standardized and thus not as harmonious as they would later become. The hand(s) of the engraver(s) lacked experience, as it were, in drawing the patterns.

This phenomenon is well-attested in other periods of Judaeen numismatics. Independent dating evidence makes this clear in at least two cases. When Herod the Great took power



Figure 3 — The three Judaeen coins types depicting a star, for comparison with the Hyrcanus specimen (not actual sizes).

a: 106 — 73 BC Alexander Jannaeus (source:

[www.JerusalemCoins.com](http://www.JerusalemCoins.com))

b: 37 BC Herod the Great (composite picture by the author)

c: AD 133 — 134 Bar Kochba Revolt (source: Tkalec AG (2002))

sixty years after Hyrcanus I, his very first dies were also cruder than those that were cut later (Fontanille 2005), and when the First Jewish Revolt against the Romans erupted in AD 66, the very first dies cut for striking the “Year One Shekel” were also cruder than all the ones that followed (Goldstein & Fontanille 2006).

Also, it is noteworthy that even if the patterns are crude and groping on the Hyrcanus die, the star itself, in spite of its small size — with dimensions of about 1.6 by 1.0 millimetres — is carefully cut with five rays well-proportioned, well-defined, and well-separated.

### A Possible Objection

One might object that a star depicted on an ancient coin is not necessarily related to an astronomical event, and undeniably stars have been symbolically important in several cultures and epochs. In Judaea, however, only three coin types in 250 years show a star (see Fig. 3), and each differs considerably from the star depicted on the Hyrcanus specimen:

- 1) Coin types on which the star is depicted on all of the dies are all regular.
- 2) The function of the star is obvious and well understood.
- 3) The star shapes are very different from the one depicted on the Hyrcanus coin.
- 4) The date when the coins were struck does not correspond to any recorded spectacular astronomical event.

In other words, only the Hyrcanus specimen seems to depict a “real” star connected to an actual astronomical event.

A quick analysis of the coin types shown in Figure 3 suggests the following:

- Coin a) Struck between 103 and 76 BC under Alexander Jannaeus: This has a highly stylized star apparently placed on the coin for its aesthetic qualities.

Coin b) Struck in 37 BC under Herod the Great. Here, the star is only a decorative piece placed at the top of a ceremonial helmet.

Coin c) Struck in AD 134 during the Bar Kochba revolt: This star is linked to a scripture recitation by Rabbi Akiba to support the leader of the revolt as the Messiah.

## Conclusion

Is the star depicted on the unlisted coin of John Hyrcanus I a direct and coeval reference to the star observed by Hipparchus of Nicaea? Naturally, we would all like to see this tiny star buttressed by additional archaeological or textual evidence. But to date, such evidence is simply not available. This coin provides us with an intriguing cluster of clues that do appear to match the facts reported by Pliny. ●

## Acknowledgements

The author wishes to express his sincere thanks to Prof. Louis Fournier and to Ken Baumheckel for reviewing the original English version of this article.

## References

Ariel, Donald T. 2000, Israel Numismatic Journal, No. 14 (Israel Exploration Society: Jerusalem), 99-124

Fontanille, J.-P. 2005, The Celator, Vol. 19, No. 2, 18-25

Fontanille, J.-P. 2006, Numismatist, Vol. 119, No. 9, 45-8

Goldstein, I. & Fontanille J.-P. 2006, American Numismatic Association Journal — Advanced Studies in Numismatics — Vol. I, No. 2 (American Numismatic Association: Colorado Springs), 8-32

Kaufman, J. Ch. 1995, Unrecorded Hasmonean Coins from the J. Ch. Kaufman collection, Part I (Israel Exploration Society: Jerusalem)

Kaufman, J. Ch. 2004, Unrecorded Hasmonean Coins from the J. Ch. Kaufman collection, Part II (Israel Exploration Society: Jerusalem).

Meshorer, Y. 2001, A Treasury of Jewish Coins (Amphora: Nyack, NY)

Meshorer, Y. 1982, Ancient Jewish Coinage (Amphora: Nyack, NY)

*Jean-Philippe Fontanille is a numismatist known for his research on Judaean coins. He is Webmaster of [www.MenorahCoinProject.org](http://www.MenorahCoinProject.org) and co-author of the book The Coins of Pontius Pilate (2001). In 2004, he received the Norman E. Wagner Award, an annual presentation of the Canadian Society of Biblical Studies. His numerous works and articles have been published in English, French, and German in various magazines and numismatic reviews in the United States, Canada, France, Belgium, Germany, Norway, and New Zealand. He resides in Montreal with his wife, Elizabeth, and their sons.*

---

## Pen & Pixel

---



The California Nebula in Perseus, a popular target for skilled amateur photographers, reveals a wealth of fine detail in this H-alpha photo by Stuart Heggie. Exposure was 18x10 minutes through an Astrodon 6-nm H-alpha filter on a Takahashi FSQ at f/5.



M33 in Triangulum is a lesser-observed neighbour to the Andromeda Galaxy. Its low surface brightness makes it a slightly more-challenging object than its better-known cousin. It is visible to the eye in good dark-sky conditions. This photo was taken by Stuart Heggie of the Toronto Centre in LRGB using a manually guided Takahashi FSQ refractor and an SBIG ST-10XME camera. Exposure was 20x3 minutes for luminance, and 8x5 minutes for each of the RGB colours.

# Where is the Radiant?

by Jeremy B. Tatum, Victoria Centre (jtatum@uvic.ca)

**ABSTRACT.** Explicit formulae are given for computing a meteor radiant in the cases where two shower meteors are seen from a single station, where a single meteor is seen from two stations, and where a single meteor is seen from a single station.

**RÉSUMÉ.** Des formules explicites pour calculer le radiant d'un météore sont présentées dans les cas suivants: deux météores d'une pluie sont observés d'une seule station; un seul météore est observé de deux stations séparées; et un seul météore est observé d'une seule station.

## 1. Introduction

Most observers know that during a meteor shower, the sky tracks of the meteors appear to diverge from a point called the radiant. Do all of us know, however, how to determine the position of the radiant from the observations? My guess would be that most people who are regularly involved in meteor work know how to do this routinely. I, however, did not know, nor could I find explicit formulae in any book on my bookshelves. Mr. E.P. Majden, of Courtenay, B.C., kindly did a literature search for me and came up with a long list of related journal articles, of which a short sample of the more relevant are cited at the end of this article. Unfortunately, many of them were in publications not readily available to me (and I suspect also to some readers), including some very early ones, and some of those that were available were not explicitly addressed to the exact problem at hand. I therefore felt that it would be useful, at least for the newcomer if not the seasoned professional, to derive and set down the necessary equations.

If a single observer sees two or more meteors and records the positions of the beginnings and ends of each, he or she could presumably plot the tracks on a star chart and see where they intersect. It should be possible, given the right ascensions and declinations of the beginning and end of two meteor trails, to calculate the position of the radiant.

Suppose there were but a single meteor? Is it possible to determine its radiant? An immediate answer to this question might be “obviously not.” However, if two observers separated by some tens of kilometres observe the same meteor, then it is indeed possible.

What if only one observer observes only one meteor? There is surely then no way in which the radiant could possibly be determined. Nevertheless, it is possible, and we shall see how.

## 2. One Observer, Two Meteors

Two meteors streak across the sky. You have recorded the right ascension and declination of the beginning and end of each. How do you project the sky tracks backwards, by calculation, to determine the common radiant from which they diverge?

Figure 1 shows two meteors. One starts at  $(\alpha_{11}, \delta_{11})$  and ends at  $(\alpha_{12}, \delta_{12})$ . The other starts at  $(\alpha_{21}, \delta_{21})$  and ends at  $(\alpha_{22}, \delta_{22})$ . The problem is to find the coordinates of the radiant,  $(\alpha, \delta)$ . Obviously, some spherical trigonometry is involved, but I spare the reader the details and I give, without derivation, the result:

$$\tan \alpha = \frac{\cos \alpha_{22} \tan \delta_{22} - \cos \alpha_{12} \tan \delta_{12} + a_1 \sin \alpha_{12} - a_2 \sin \alpha_{22}}{\sin \alpha_{12} \tan \delta_{12} - \sin \alpha_{22} \tan \delta_{22} + a_1 \cos \alpha_{12} - a_2 \cos \alpha_{22}}, \quad (1)$$

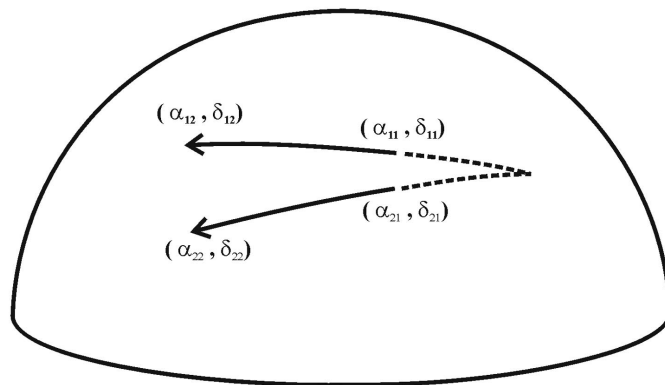

Figure 1 — Two meteors streak across the sky. The coordinates of the beginning and end of each are recorded. How do you calculate the coordinates  $(\alpha, \delta)$  of the radiant?



where 
$$a_1 = \frac{\tan \delta_{11}}{\sin(\alpha_{11} - \alpha_{12})} - \frac{\tan \delta_{12}}{\tan(\alpha_{11} - \alpha_{12})}, \quad (2)$$

and 
$$a_2 = \frac{\tan \delta_{21}}{\sin(\alpha_{21} - \alpha_{22})} - \frac{\tan \delta_{22}}{\tan(\alpha_{21} - \alpha_{22})}; \quad (3)$$

and 
$$\tan \delta = \cos(\alpha - \alpha_{12}) \tan \delta_{12} + \sin(\alpha - \alpha_{12}) [\csc(\alpha_{11} - \alpha_{12}) \tan \delta_{11} - \cot(\alpha_{11} - \alpha_{12}) \tan \delta_{12}] \quad (4)$$

or 
$$\tan \delta = \cos(\alpha - \alpha_{22}) \tan \delta_{22} + \sin(\alpha - \alpha_{22}) [\csc(\alpha_{21} - \alpha_{22}) \tan \delta_{21} - \cot(\alpha_{21} - \alpha_{22}) \tan \delta_{22}] \quad (5)$$

Although the formulae look long, they are quite straightforward to apply, as can be found by trying the following numerical example.

$$\alpha_{11} = 6 \text{ hours} \quad \delta_{11} = +65^\circ$$

$$\alpha_{12} = 1 \text{ hour} \quad \delta_{12} = +75^\circ$$

$$\alpha_{21} = 5 \text{ hours} \quad \delta_{21} = +35^\circ$$

$$\alpha_{22} = 3 \text{ hours} \quad \delta_{22} = +15^\circ$$

$$\text{then } \alpha = 7.26 \text{ hours} \quad \delta = +43.8$$

The calculations can be done by hand calculator or automatically by computer. Particularly in the latter case, there are some details worth noting as follows:

1. The trigonometric functions in your computer language probably expect the angular arguments to be in degrees or in radians. Right ascension is normally expressed in hours, and the appropriate conversion must be made. The appropriate conversion is 1 hour =  $15^\circ$  (not  $15^\circ \cos \delta$ , since the formulae are calculated for great-circle triangles).
2. Problems may arise if the meteor crosses the equinoctial colure, *i.e.* if the right ascension changes from 23 hours to 0 hours. Similar problems arise if the meteor and its radiant are on opposite sides of the equinoctial colure.
3. Negative declinations can cause a problem. For example, if the declination is  $-17^\circ 22'$ , you have to make sure that your computer counts the arcminutes as well as the degrees as negative. That is easy — but just make sure that your program also gets the signs right if the declination is  $-0^\circ 22'$ .
4. The solution of equation (1) should yield two values of  $\alpha$  differing from each other by  $180^\circ$ , and your computer will probably — unless instructed otherwise — print out only one of them, not necessarily the correct one. The two solutions correspond to the two points in which the great circles of the two meteor sky tracks intersect on the celestial sphere.
5. Either equation (4) or equation (5) can be used for calculating  $\delta$ . It is recommended that both be used as a check against mistakes. The answers should, of course, be identical. Since the range of  $\delta$  is from  $-90^\circ$  to  $+90^\circ$ , a quadrant ambiguity for  $\delta$  is less likely than the quadrant ambiguity for  $\alpha$ .
6. If either meteor moves exactly along an hour circle (*i.e.* if  $\alpha_{11} = \alpha_{12}$  or  $\alpha_{21} = \alpha_{22}$ ), there will be problems with equations (2) or (3).

How to get around these problems is a matter of the details of the program you write and the language in which it is written, but it is important to be aware of them, particularly if your program is intended as a “user-friendly” program that will always work for anyone under all circumstances.

## 2. One Observer, Many Meteors

If a single observer sees many meteors belonging to a single shower and projects their sky tracks backwards, they will not all intersect at a single point because of errors of measurement. (I here assume that all of the meteors are seen within a short time interval, say not more than an hour. This is because, during the course of a night, the radiant moves a little.) So, how does one determine the best value of the radiant given a set of apparently conflicting data? I suspect that those observers who are not mathematically inclined will determine (by plotting on an atlas or by calculation as described above) the intersection point of all pairs of meteors in turn, and will then stick a pin roughly in the middle of all the points so determined. This is probably as good a way as any, and the result may not be all that different from the result obtained by their mathematically gifted brethren using more sophisticated methods. There are correct statistical methods of dealing with this problem. However, I do not discuss them in this article because in the list of papers cited at the end of this article is one that solves this problem in a method that is simultaneously elegant, rapid, and rigorous, and I don't think I can improve upon it. The paper referred to is that of Steyaert (1984). In brief, the method involves calculating the eigenvalues and eigenvectors of a symmetric matrix and, as the author points out, is identical to the problem of finding the principal moments and axes of a solid body or to other similar physical problems. This may sound like jabberwocky to some readers, but it is nevertheless worth citing the paper because of the elegance and speed of the method, and also because it is probable that some readers who have managed to struggle through a physics degree will recognize the problem and may already have computer programs that will solve the problem instantly.

## 3. One Meteor, Two Observers

In the first section, I described how to calculate the position of the radiant of two meteors by calculating where the sky tracks of the two meteors intersect. Is it possible to determine the radiant of only *one* meteor? Although one is at first inclined to say "No, of course not," in fact it *is* possible — provided that two well-separated observers (50 km or more is a good start!) observe the same meteor. In this section, I show how.

For the purpose of this article, we assume a Flat Earth. This not only makes the mathematics much easier, but for visual observations, it is a quite adequate approximation. It is tantamount to assuming (i) that the height of any meteor observer above sea level is much smaller than the height of the meteor above sea level, and (ii) that the height of the meteor is much smaller than the radius of Earth. I think most readers will allow that this is fair. If two photographs are obtained, however, and if they can be measured with a precision-measuring microscope, the analysis becomes rather more complicated. Many refinements beyond the curvature of Earth and the height of the observers (the refraction of Earth's atmosphere is one that comes to mind) must be taken into account. Readers who wish to pursue this in more detail are referred to a paper by Tatum and Bishop (2005) in which precise measurements were made of a pair of photographs obtained of a meteor from two stations 45 km apart in Nova Scotia. I mention here only one important conclusion from that paper — namely that, to obtain the utmost precision from photographic measurements, it is desirable that the time of the appearance of the meteor should be recorded to a precision of a second (observers please note!). For the purposes of the present article, we stick to the approximation of a Flat Earth.

First, a bit of geometry. How do we specify the direction to a point on the celestial sphere? One way is to specify the right ascension and declination of the point. In this section, however,

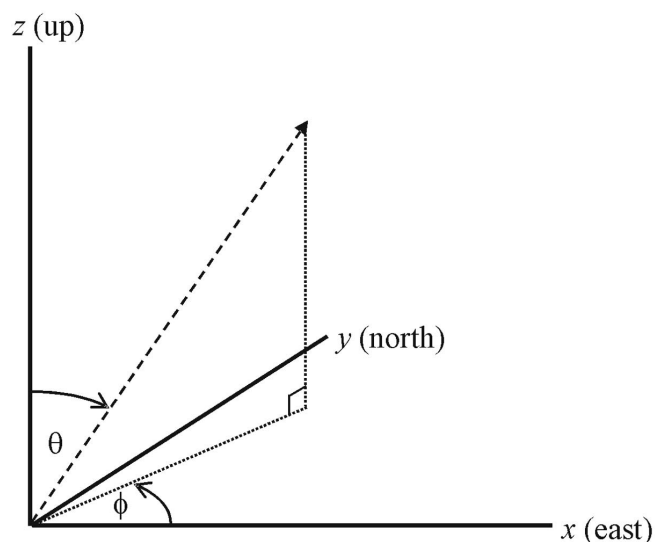

Figure 2 — Illustrating the altazimuth (spherical) coordinates  $(\theta, \phi)$

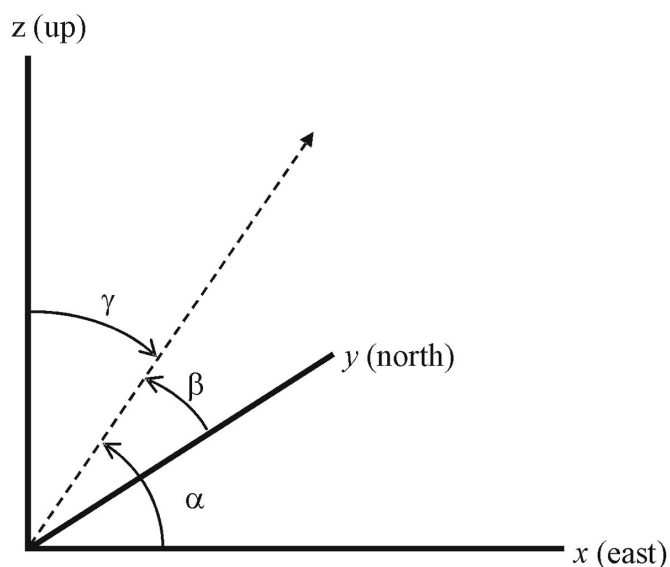

Figure 3 — Illustrating the angles  $(\alpha, \beta, \gamma)$ , whose cosines are the *direction cosines*.

we use altazimuth coordinates, and we assume that most mathematically minded astronomers will know how to make the conversion.

Figure 2 shows how we can specify the direction to a point on the celestial sphere by two angles,  $\theta$  and  $\phi$ . We set up an  $xyz$ -coordinate system, centred at one of the observers. The  $x$ -axis points east, the  $y$ -axis points north, and the  $z$ -axis points to the zenith. The angle  $\theta$ , which is just the complement of the altitude, is the zenith distance. The angle  $\phi$  is the azimuth, measured counterclockwise from east. (In some contexts azimuth is measured clockwise from north, but the convention I use here is consistent with the usual mathematical practice for spherical coordinates.)

A second, alternative way in which we can describe the direction to a point is to specify the angles  $\alpha$ ,  $\beta$  and  $\gamma$  as shown in Figure 3. These are just the angles that the vector of interest makes with the  $x$ -,  $y$ -, and  $z$ -axes respectively. More commonly, one specifies the cosines of these angles: these are often denoted by  $l$ ,  $m$ , and  $n$  respectively, and are called the *direction cosines*. The angle  $\gamma$  is the same as the angle  $\theta$  in Figure 2. In fact, only two angles are necessary to describe the direction to a point on the celestial sphere, and the three direction cosines are always related to each other through the theorem of Pythagoras, which, in this context, takes the form

$$l^2 + m^2 + n^2 = 1. \quad (6)$$

If you know any two of them, you automatically know the third.

Now, after that bit of geometry, on to the meteor. Let us suppose that the first observer, who is at the origin of our coordinate system, determines that the directions to two points on the sky track of the meteor are described by the coordinates  $(\theta_{11}, \phi_{11})$  and  $(\theta_{12}, \phi_{12})$ . In that case it can be shown that the equation

$$a_1x + b_1y + c_1z = 0, \quad (7)$$

in which

$$a_1 = \sin\theta_{11} \cos\theta_{12} \sin\phi_{11} - \sin\theta_{12} \cos\theta_{11} \sin\phi_{12}, \quad (8)$$

$$b_1 = \sin\theta_{12} \cos\theta_{11} \cos\phi_{12} - \sin\theta_{11} \cos\theta_{12} \cos\phi_{11}, \quad (9)$$

and

$$c_1 = \sin\theta_{11} \sin\theta_{12} \sin(\phi_{12} - \phi_{11}), \quad (10)$$

represents the plane containing the meteor and the first observer.

For example, suppose that the first observer determines that one point on the sky track is at  $\theta_{11}=15^\circ$ ,  $\phi_{11}=80^\circ$  and a second point on the sky track is at  $\theta_{12}=52^\circ$ ,  $\phi_{12}=44^\circ$ . In that case, the plane containing the meteor and the first observer is described by the plane

$$-0.371822x + 0.519863y - 0.199880z = 0. \quad (11)$$

Now suppose that a second observer, who is situated at coordinates  $(x_0, y_0, 0)$  with respect to the first, determines that one point on the sky track is at  $(\theta_{21}, \phi_{21})$  and a second point on the sky track is at  $(\theta_{22}, \phi_{22})$  (Note that it is not in any way necessary that the two points measured by the two observers are the same two points.) In that case it can be shown that the equation

$$a_2x + b_2y + c_2z + d_2 = 0, \quad (12)$$

in which

$$a_2 = \sin\theta_{21} \cos\theta_{22} \sin\phi_{21} - \sin\theta_{22} \cos\theta_{21} \sin\phi_{22}, \quad (13)$$

$$b_2 = \sin\theta_{22} \cos\theta_{21} \cos\phi_{22} - \sin\theta_{21} \cos\theta_{22} \cos\phi_{21}, \quad (14)$$

$$c_2 = \sin\theta_{21} \sin\theta_{22} \sin(\phi_{22} - \phi_{21}), \quad (15)$$

and

$$d_2 = -a_2x_0 - b_2y_0. \quad (16)$$

represents the plane containing the meteor and the second observer.

For example, suppose that the second observer is 50 km east and 12 km north of the first observer; that is,  $x = 50$  km and  $y = 12$  km. Suppose that the second observer determines that one point on the sky track is at  $\theta_{21}=24^\circ$ ,  $\phi_{21}=159^\circ$  and a second point on the sky track is at  $\theta_{22}=40^\circ$ ,  $\phi_{22}=64^\circ$ . In that case, the plane containing the meteor and the second observer is described by

$$-0.416126x + 0.548302y - 0.260450z + 14.226692 = 0. \quad (17)$$

The atmospheric trajectory of the meteoroid is where these two planes (equations (7) and (12), or, numerically, equations (11) and (17)) intersect. That is, equations (7) and (12) together represent the atmospheric trajectory of the meteoroid. As soon as you have obtained these two equations, you can do all sorts of things with them. For example, you can calculate the height of the meteoroid at any point along its trajectory. Alternatively, if you eliminate  $z$  from the two equations, you get an equation in  $x$  and  $y$ , which represents the ground track of the meteor. If you put  $z = 0$  in each of the equations, and then solve the resulting two equations for  $x$  and  $y$ , you will get the coordinates of the point where the meteoroid would hit the ground if it continued to travel in a straight line. However, our interest in this article is in finding the position of the radiant.

To find the direction cosines of the atmospheric trajectory (and hence of the direction to the radiant) all we need do is find any two points on the line represented by equations (11) and (17), and find the direction cosines of the line joining these two points. For example, we can set  $x = 0$  in equations (11) and (17) to find the  $(y, z)$  coordinates where the linearly extrapolated trajectory would intersect the plane  $x = 0$ ; and we can set  $z = 0$  in equations (11) and (17) to find the  $(x, y)$  coordinates where the linearly extrapolated trajectory intersects the ground. (This does not imply that the meteoroid would continue to move in a straight line until it hit the ground; we are merely determining the direction cosines of a straight line.) From this, we easily find that two points on the trajectory are

$$(0.000000, 110.2024, 286.6227)$$

and  $(593.6804, 424.6185, 0.000000).$

It is easy to verify that these satisfy equations (11) and (17). We can calculate the distance  $s$  between these two points, thus:

$$s = \sqrt{(x_2 - x_1)^2 + (y_2 - y_1)^2 + (z_2 - z_1)^2}. \quad (18)$$

The direction cosines of the atmospheric trajectory (and hence of the direction to the radiant) are given by

$$l = (x_2 - x_1) / s, \quad m = (y_2 - y_1) / s, \quad n = (z_2 - z_1) / s. \quad (19)$$

Thus, the altazimuth coordinates of the radiant have been calculated, and these may be converted to right ascension and declination in the usual manner.

#### 4. One Meteor, One Observer

I have often had to point out to fireball witnesses that it is not possible to determine the direction of motion of a fireball from observations of a fireball from a single station. For example, if a witness is facing north and he sees a fireball in front of him moving from left to right, he is inclined to say “The fireball was moving to the east.” In fact, it is not possible, even in the roughest approximation, to determine the direction of motion, as illustrated in Figure 4. In this figure, an observer is facing north, and he sees two meteors, each of which he sees move “from left to right,” whereas in fact one of the meteors is moving almost due north, and the other almost due south. Neither is moving “to the east.” The most that the witness can record is that the meteor moved “from left to right.” To specify the direction of motion, we would have to know the angle  $\alpha$ , which could be anything from  $1^\circ$  to  $179^\circ$ .

If we are to determine the direction of motion (and hence the radiant) we need to be able to determine the angle  $\alpha$ . While this would seem at first to be impossible, in fact it is possible in principle to determine  $\alpha$  if the observer has photographed the meteor with a rotating shutter in front of the camera. This has been

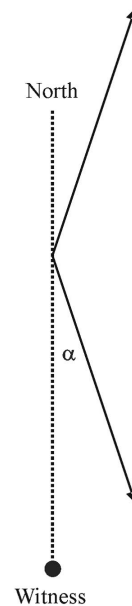

Figure 4. — Two meteors to the north of a witness move “from left to right.” One is moving almost to the north; the other, almost to the south. Both appear to the witness to move from left to right.

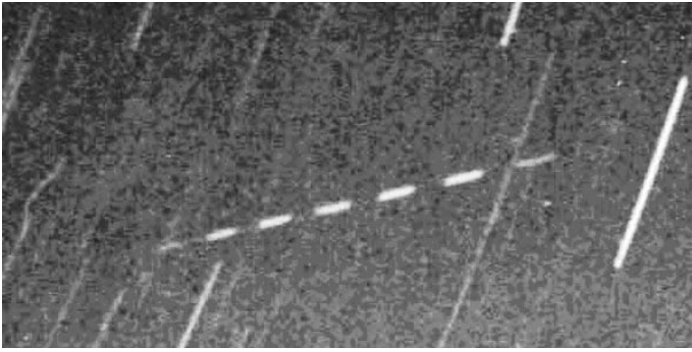

Figure 5 — Perseid meteor photographed through a rotating shutter at ten interruptions per second. The exposures and the interruptions are equal in length. It appears that the exposures look a little longer than the interruptions. This could be caused by photographic spreading of the image or by a finite train duration, or both, a factor that needs to be taken into account during measurement. Exposure from August 12, 1993<sup>d</sup> 07<sup>h</sup> 35<sup>m</sup> to 07<sup>h</sup> 50<sup>m</sup> UT. Camera: Exacta VX1000, focal length 50 mm, aperture  $f/2.8$ . Photographed from Courtenay, British Columbia, by E.P. Majden.

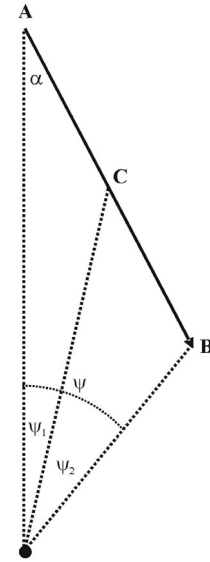

Figure 6 — The halfway point of the atmospheric trajectory does not divide the observed sky track into two equal angles.

discussed, for example by Shiba (1995), though that paper has suffered somewhat during translation from the Japanese, and the present article adopts a different approach.

If a rotating shutter has been used, the image is broken up into a series of dashes (Figure 5), which represent equal intervals of time. If the meteor is moving at constant speed through the atmosphere, the dashes also represent equal distances in space. In the analysis that follows, I am going to make the assumption, at least to begin with, that the meteor is moving through the atmosphere at constant speed. This is done primarily to keep the analysis simple and to illustrate the principles. Later I shall examine whether or not this is a realistic assumption.

The key to the method is to understand that, if we have obtained a photograph with a rotating shutter in front of the camera, and if the meteor is moving at constant speed, we can identify the point that is halfway along the atmospheric trajectory. However, this point will not be halfway along the sky track of the visual meteor. It will not divide the sky track into two equal parts. The ratio of the two parts into which the “halfway point” C divides the sky track depends on the angle  $\alpha$ . Thus, if we measure the ratio, we can determine  $\alpha$  and hence determine the direction cosines of the atmospheric trajectory, and the radiant. I illustrate the situation in Figure 6, in which the halfway point C of the trajectory divides the angle subtended by the trajectory into two unequal angles  $\psi_1$  and  $\psi_2$ .

Those who enjoy geometry will quickly be able to show that, if we define  $R$  as the ratio of the sines of these two angles, *i.e.* if

$$R = \frac{\sin \psi_2}{\sin \psi_1}, \quad (20)$$

then 
$$R = \sin \psi \cot \alpha + \cos \psi, \quad (21)$$

or 
$$\tan \alpha = \frac{\sin \psi}{R - \cos \psi}. \quad (22)$$

Thus, if a meteor moves across the sky for an angular distance  $\psi$ , we just identify the halfway point C, measure  $\psi_1$  and  $\psi_2$ , calculate  $R$ , and then we immediately obtain  $\alpha$ . I illustrate the relation between  $\alpha$ ,  $\psi$  and  $R$  in Figure 7. The reader will observe and be cautioned from Figure 7 that there are some conditions ( $R < 1$ ) under which  $\alpha$  is well determined, and others ( $R > 1$ ) in which it is relatively poorly determined.

Two examples are illustrated in Figure 8. In Figure 8(a) a meteor of angular extent  $60^\circ$  is divided by its halfway point so that  $\psi_1 = 20^\circ$  and  $\psi_2 = 40^\circ$  ( $R = 1.88$ ). It follows from equation 22, or from Figure 7, or from a scale drawing (Figure 8(a)) that  $\alpha = 32^\circ$ . In Figure 8(b) a meteor of angular extent  $30^\circ$  is divided by its halfway point so that  $\psi_1 = 20^\circ$  and  $\psi_2 = 10^\circ$  ( $R = 1.51$ ). It follows from equation 22, or from Figure 7, or from a scale drawing (Figure 8(b)) that  $\alpha = 126^\circ$ .

A second method using a similar principle is to measure the ratio of the angular speeds of the meteor at two points along its

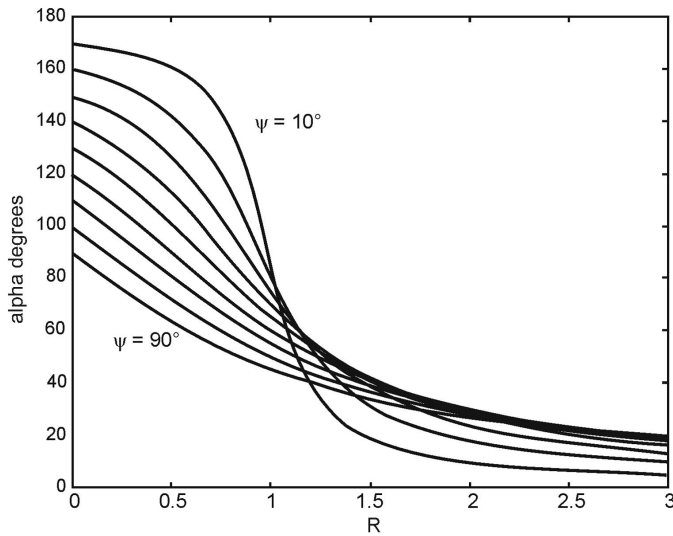

Figure 7. — The relation between  $\alpha$ ,  $\psi$  and  $R$ . The graphs are drawn for  $\psi = 10^\circ$  to  $90^\circ$  in steps of  $10^\circ$ .

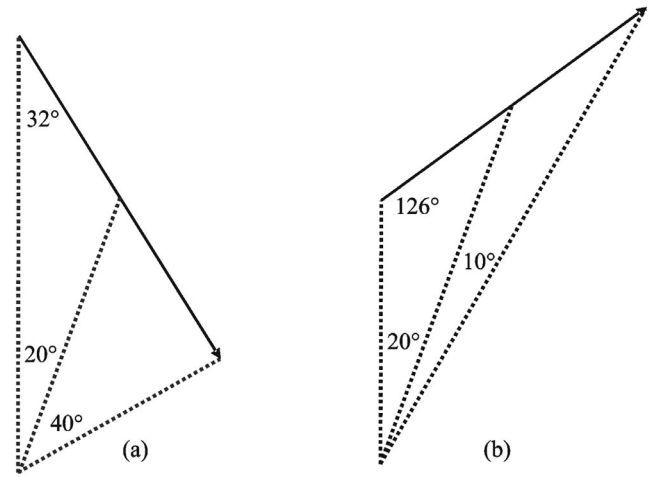

Figure 8 — Two examples relating  $\alpha$ ,  $\psi$  and  $R$ .

sky track. The angular speed of a meteor photographed through a rotating shutter is proportional to the length of the dashes into which the image is broken by the shutter. It is therefore not necessary to measure the angular speed in degrees per second; it is only necessary to measure the lengths of the dashes at two points, and calculate their ratio. An excellent example of a photographic meteor trail broken by a rotating shutter and clearly showing the change in angular speed along the trail is shown by Gural (2006).

I shall still, for simplicity, make the assumption that the linear speed of the meteor is constant. Figure 6 will suffice to illustrate the method. The angular speed  $\omega$  of the meteor is  $d\psi/dt$ , and geometry shows that

$$\omega \propto \sin^2(\alpha + \psi). \quad (23)$$

If we now measure the angular speeds  $\omega_1$  and  $\omega_2$  at any two points  $\psi_1$  and  $\psi_2$  along the track, then we have two equations similar to equation (23), and we can solve them for  $\alpha$ :

$$\tan \alpha = \frac{\sin \psi_1 - C \sin \psi_2}{\cos \psi_1 - C \cos \psi_2}, \quad (24)$$

where

$$C = \sqrt{\omega_1 / \omega_2}, \quad (25)$$

or the square root of the ratio of the dash lengths at any the two chosen points on the track.

By one method or another, we have found  $\alpha$ . I assume also that we can determine the zenith distance and azimuth of the two points on the sky track. It remains to determine the direction cosines of the atmospheric trajectory, and hence the radiant. The situation is shown in Figure 9.

The angle  $\alpha$  is known (we have just found it) and the angle  $\psi$  can be expressed in terms of the coordinates of the two points A and B on the sky track, by making use of the cosine formula from spherical trigonometry:

$$\cos \psi = \cos \theta_1 \cos \theta_2 + \sin \theta_1 \sin \theta_2 \cos(\phi_1 - \phi_2). \quad (26)$$

The coordinates of A and B respectively are

$$(r_1 \sin \theta_1 \cos \phi_1, r_1 \sin \theta_1 \sin \phi_1, r_1 \cos \theta_1) \quad (27)$$

and

$$(r_2 \sin \theta_2 \cos \phi_2, r_2 \sin \theta_2 \sin \phi_2, r_2 \cos \theta_2) \quad (28)$$

Hence the direction cosines of the atmospheric trajectory AB of the meteor are

$$\left( \frac{r_1}{r} \sin \theta_1 \cos \phi_1 - \frac{r_2}{r} \sin \theta_2 \cos \phi_2, \frac{r_1}{r} \sin \theta_1 \sin \phi_1 - \frac{r_2}{r} \sin \theta_2 \sin \phi_2, \frac{r_1}{r} \cos \theta_1 - \frac{r_2}{r} \cos \theta_2 \right). \quad (29)$$

We do not know any of the distances, but we do know their ratios:

$$\frac{r_1}{r} = \frac{\sin(\psi + \alpha)}{\sin \psi} \quad (30)$$

and 
$$\frac{r_2}{r} = \frac{\sin \alpha}{\sin \psi}. \quad (31)$$

As soon as we have found the direction cosines  $(l, m, n)$ , the coordinates  $(\theta, \phi)$  of the radiant are found from

$$l = \sin \theta \cos \phi, \quad (32)$$

$$m = \sin \theta \sin \phi \quad (33)$$

and 
$$n = \cos \theta \quad (34)$$

In both of these methods, we have determined the angle  $\alpha$  from an analysis of the spacings of the dashes on a photograph of a meteor interrupted by a rotating shutter on the assumption that the speed of the meteor through the atmosphere is constant. We now need to address ourselves to the question as to whether this assumption is justified. This is very easy to answer as soon as we can answer another question: Why does a meteor glow? A meteor glows (“blazes” would be a better description) because kinetic energy is being converted to heat and light. When a meteor hits Earth’s atmosphere, the effect is somewhat akin to a novice diver doing a belly-flop off the top board — though it is much more violent than that. The meteor violently decelerates and the loss of kinetic energy is what causes the meteor to blaze. So a good guide is: if you can see the meteor, it is not moving with constant speed!

Does this mean that the method described is invalid and that you cannot determine the radiant of a single meteor from a shutter-interrupted photograph from a single station? Not quite, for, if you knew the details of the deceleration, you could apply the same principles to determine  $\alpha$ ; the analysis would just be a little more complicated. Unfortunately, the change in the spacings of the dashes on the photograph does not by itself tell you the deceleration, because the change in the spacings is determined both

by the deceleration and the perspective effect of the direction of motion. It is possible, however, to make some plausible models for the deceleration. For example, you might have a reasonable model in which the atmospheric resistance is proportional to the square of the speed (which is typical for nonlaminar flow) and to the density of the air, and the density of the air falls off exponentially with height (which it would do in an isothermal atmosphere). In such a model, over a wide range of parameters the speed decreases approximately linearly with distance covered. This is shown mathematically by Tatum (1999). More-sophisticated models would take account of the loss of mass of the meteoroid during its flight through the atmosphere. In any case, once you have a reasonably plausible model for the deceleration, you can then, at least in principle, use the change in angular speed (*i.e.* in the dash spacing) to determine the angle  $\alpha$  and hence the radiant.

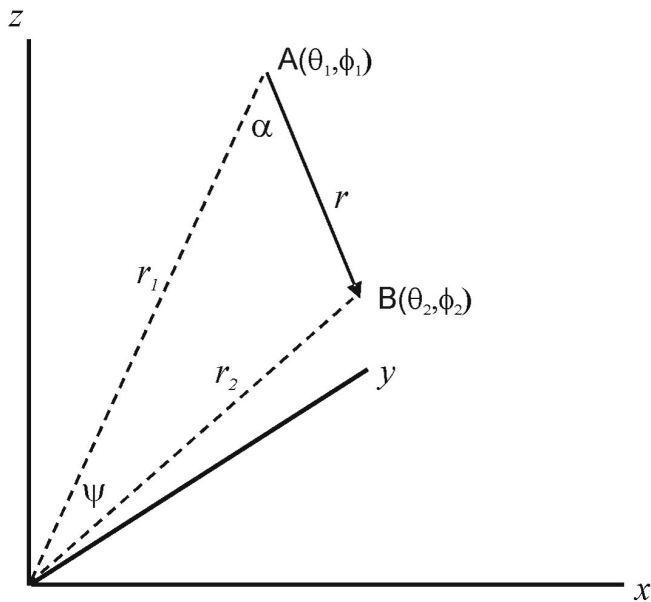

## 5. The True Geocentric Radiant

The direction to the point in the sky from which shower meteors appear to diverge is also the direction from which the meteor appears to approach Earth from outside, and this is what we have

Figure 9 — We know the altazimuth coordinates of two points on the sky track, and we have determined the angle  $\alpha$ . It remains to determine the direction cosines of the atmospheric trajectory.

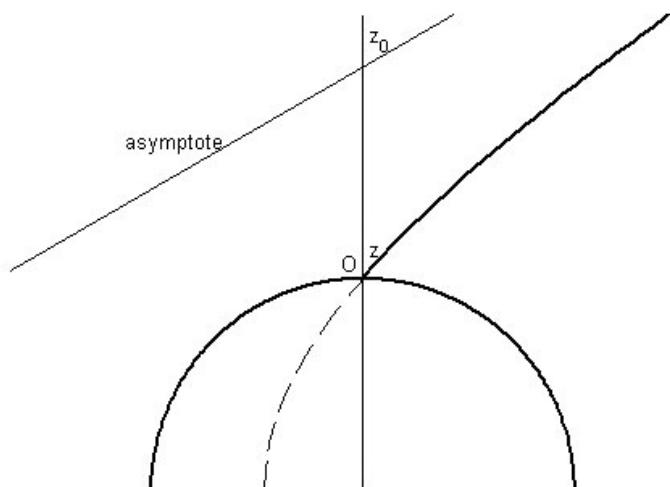

Figure 10 — Illustrating true and apparent geocentric radiants. The measured and  $z$  is the zenith distance of the apparent radiant; we need to determine the zenith distance  $z_0$  of the true radiant.

zenith distance of the *apparent geocentric radiant*. What the orbit computer needs, however, is the direction from which the meteoroid originally approached Earth before it was deviated by Earth's gravity. The original direction of approach was along the asymptote to the hyperbola, and the angle  $z_0$  in the figure is the zenith distance of the *true geocentric radiant*. It is seen that the zenith distance  $z$  of the apparent geocentric radiant is always less than the zenith distance  $z_0$  of the true geocentric radiant. The effect of Earth's gravity is always to move the apparent radiant closer to the zenith than the true radiant, and this effect is known as *zenith attraction*. The azimuth is unaffected.

The amount of the zenith attraction depends on the speed of the meteoroid. The relation between the true and apparent geocentric zenith distances and the speed, which I quote here without derivation, is

$$\tan \frac{1}{2}(z_0 - z) = \frac{V_0 - V_1}{V_0 + V_1} \tan \frac{1}{2}z. \quad (35)$$

Here  $V_0$  is the speed of the meteoroid on arrival at the upper atmosphere of Earth, and  $V_1$  is the speed it originally had when it was a very long way along the asymptote of the hyperbola. From energy considerations, the two are related by

$$V_0^2 = V_1^2 + \frac{2GM}{R}, \quad (36)$$

where  $G$  is the universal gravitational constant and  $M$  and  $R$  are the mass and radius, respectively, of Earth. Numerically, this is

$$V_0^2 = V_1^2 + 125.1, \quad (37)$$

where the speeds are in  $\text{km s}^{-1}$ .

Since meteoroid orbits are sometimes published with speedy abandon, it must here be pointed out that  $V_0$  is exceedingly difficult to determine. It can be determined from photographic or from radar observations. A photograph obtained with a rotating shutter will give the angular speed of the meteor across the sky, but this cannot be translated into linear speed unless we know two things, namely the distance of the meteoroid, and its direction of motion through the atmosphere, and this requires simultaneous photographs (at least one of which must be through a rotating shutter) from two stations, and a considerable amount of careful measurement and calculation. Furthermore,  $V_0$  is the speed of the meteoroid when it arrives at the top of the atmosphere, not the speed as it travels through the atmosphere. Thus, allowance must be made for the atmospheric deceleration. Radar observations will give both the speed and the distance of the meteoroid, but, although I do not discuss radar work here, (mainly because I have no personal experience in it) many of the same difficulties (as well as other difficulties peculiar to the radar technique) also apply there.

been calling "the" radiant. Technically, what we have been calling "the" radiant, and what we have been describing how to determine from our observations, is the *apparent geocentric radiant*. Indeed the principal object of this article has been to show how to determine the apparent geocentric radiant, and for that purpose, this article could comfortably end here.

For those who wish to go further, however, and to calculate, for example, the pre-encounter orbit of a meteoroid, there are two other "radiants" of interest. It is beyond the purpose of this article to describe the lengthy calculations needed to compute an orbit, but it seems appropriate in an article with the chosen title at least to mention briefly the other two "radiants." The first of these, which I describe in this section, is the *true geocentric radiant*. The second, to be described in the following section, is the *heliocentric radiant*.

As a meteoroid in interplanetary space approaches Earth, the gravitational attraction of Earth causes the meteoroid to deviate from its original path and to approach Earth on a hyperbolic trajectory. This is shown in Figure 10, in which the meteoroid encounters Earth at a point  $O$ . The angle  $z$  in the figure is the



## 6. The Heliocentric Radiant

Hitherto in this article we have shown how to determine the radiant in either equatorial coordinates  $(\alpha, \delta)$  or in altazimuth coordinates  $(\theta, \phi)$ . It will be no surprise to understand that orbit computers normally wish to work in ecliptic coordinates  $(\lambda, \beta)$ , where  $\lambda$  and  $\beta$  are respectively ecliptic longitude and ecliptic latitude. Converting from one basis set of coordinates to another is a matter of rotation of axes. It will be understood that those who compute orbits for a living know how to do this routinely, and I do not discuss how here. Those who make their living from other endeavours may be satisfied to suppose that the transformation of coordinates is something that can be readily done by those who are in the know. (It is done by means of an Eulerian rotation matrix.)

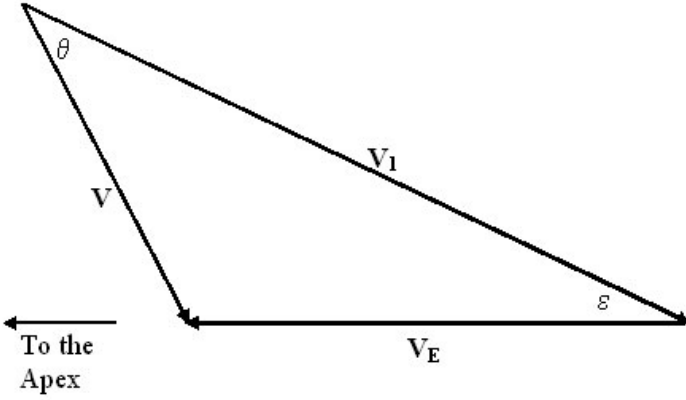

Figure 11. Illustrating aberration.

In any case, we shall suppose that, by this time, we have determined the initial speed  $V_1$  of the meteoroid relative to Earth as it approached from a great (relative to the radius of Earth) distance along the asymptote, as well as the direction of motion, *i.e.* the direction to the true geocentric radiant. Knowing both the speed  $V_1$  and the direction means that we know the initial velocity  $\mathbf{V}_1$  of the meteoroid relative to Earth.

But we need to know the velocity  $\mathbf{V}$  of the meteoroid relative to the Sun. The velocity of the meteoroid relative to Earth,  $\mathbf{V}_1$ , is the vector difference between its velocity relative to the Sun,  $\mathbf{V}$ , and the velocity of Earth relative to the Sun,  $\mathbf{V}_E$ . In symbols, this is

$$\mathbf{V}_1 = \mathbf{V} - \mathbf{V}_E. \quad (38)$$

The geometric meaning of this equation is illustrated in Figure 11.

In Figure 11, the Earth is moving towards the apex of the Earth's way with velocity  $\mathbf{V}_E$ . Relative to the Sun, the velocity of the meteor of the meteor is  $\mathbf{V}$ . The direction from which it comes is the heliocentric radiant. Relative to Earth, the velocity of the meteor is  $\mathbf{V}_1$ . The direction from which it comes is the true geocentric radiant. In the figure, the angle between the direction to the apex of the Earth's way and the true geocentric radiant is denoted by  $\epsilon$ . We note that the effect of Earth's motion is always such that the true geocentric radiant is closer to the apex of the Earth's way than is the heliocentric radiant. The effect is quite analogous to the better-known aberration of light, and indeed in this context is often called just aberration. The analogy of the fast-walking man holding his umbrella tipped forward to shield himself from the vertically-falling rain is probably well known.

In Figure 11,  $\mathbf{V}_E$ ,  $\mathbf{V}_1$ , and  $\epsilon$  are known;  $\epsilon$  and  $V$  are to be determined. It is straightforward geometry to see that

$$\tan \theta = \frac{V_E \sin \epsilon}{V_1 - V_E \cos \epsilon}, \quad (39)$$

and

$$V = \frac{V_E \sin \epsilon}{\sin \theta}. \quad (40)$$

The apex and the true geocentric and heliocentric radiants are on a single great circle, and, knowing the ecliptic coordinates of the first two as well as the angle  $\epsilon$  will enable the investigator (who is assumed to be skilled at spherical astronomy!) to calculate the ecliptic coordinates of the third.

While there are still some steps to go before the pre-encounter orbit of the meteoroid can be calculated, we have by this time obtained the heliocentric velocity of the meteoroid at the time of Earth encounter, and this is the essential information needed in order to commence the orbital calculation

## Acknowledgement

I thank Mr. Ed Majden for the photograph reproduced as Figure 5, and for drawing my attention to the earlier literature on the subject. I also acknowledge the careful and conscientious work of the referee, whose suggestions led to a number of improvements to the article. ●

Dr. Jeremy Tatum is a retired Professor of Physics and Astronomy at the University of Victoria, where for 31 years he taught and conducted research on atomic and molecular spectroscopy, the composition of comets, and the orbits of asteroids — particularly near-Earth asteroids. An asteroid bears the name “Tatum” in honour of Dr. Tatum.

## References

- Ceplecha, Z. 1952, *Bull. Astron. Inst. Czech.*, 3, 95  
 Chapman, H.W. 1905, *MNRAS*, 65, 238  
 Cookson, B. 1901, *MNRAS*, 61, 132  
 Denning, W.F. 1887, *The Observatory*, 10, 358  
 Denning, W.F. 1905, *MNRAS*, 65, 592  
 Gural, P. 2006, *Meteor Trails (American Meteor Society)*, 31, 3  
 McIntosh, R.A. 1940, *JRASC*, 34, 373  
 Plummer, H.C. 1901, *MNRAS*, 61, 368  
 Prentice, J.P.M. 1930, *JBAA*, 40, 285  
 Shiba, Y. 1995, *Earth, Moon, and Planets*, 68, 503  
 Steyaert, C. 1984, *Bull. Astron. Inst. Czech.*, 35, 312  
 Steyaert, C. 1986, *JIMO*, 14, 126  
 Tatum, J.B. 1999, *Meteoritics and Planetary Science*, 34, 571  
 Tatum, J.B. & Bishop, R. 2005, *JRASC*, 99, 61  
 Whipple, F.L. & Wright, F.W. 1957, *Smiths. Contr. Astroph.*, 1, 239

## ADVERTISE IN THE *JOURNAL*

The *Journal* accepts commercial advertising. By advertising within these pages you will reach the about 4500 members of the RASC, who are the most active and dedicated amateur and professional astronomers in Canada. The *Journal* is also distributed by subscription to university libraries and professional observatories around the world.

### ADVERTISING RATES

SIZE	One Insertion	Three Insertions
<i>1/8 Page</i>	\$125	\$115
<i>1/4 Page</i>	\$175	\$160
<i>1/2 Page</i>	\$250	\$225
<i>Full Page</i>	\$375	\$340
<i>Inside Front Cover</i>	\$750	\$550
<i>Inside Back Cover</i>	\$500	\$425
<i>Outside Back Cover</i>	\$750	\$550

For information or to receive a copy of our advertising rate card contact:

**RASC Journal Advertising**

PO Box 2254  
 Melville SK S0A 2P0  
 phone: (306) 728-4819  
 email: ads@rasc.ca

# DSLR Astrophotography, Part II

by Doug George, Ottawa Centre ([dgeorge@cyanogen.com](mailto:dgeorge@cyanogen.com))

**W**hile many different types of digital cameras can be found for sale in stores and on Web sites, the best choice for astronomical photography is clearly a Digital Single-Lens Reflex (DSLR) camera. DSLR cameras allow the user not only to look through the viewfinder and see exactly what the lens is seeing, but also to swap lenses. And not only can you pick a lens optimized for astronomy, you can also easily hook these cameras onto a telescope.

Not surprisingly, there has been some consolidation in the camera industry. Companies have merged and/or exited the field. At this point in time, only Canon, Nikon, and Olympus remain. Sony has announced a new DSLR camera, but it is not clear at this time whether it will be successful commercially or suitable for astrophotography.

Many photographers have invested a fair bit in lenses for their old film cameras, and so it may be tempting to stick with the same brand when switching to a DSLR. That may be a mistake. Digital sensors are rarely the same physical size as a 35-mm frame, resulting in a new image scale on the sensor. Older lenses may not be compatible with the new designs, and new lenses from your favourite manufacturer may not be up to the challenges of astronomy. Where older cameras depended on the type of film for particular results, digital cameras have the “film” built in, and the image now also depends on the character of the sensors and the processing done by the manufacturer’s software. By sticking with the past, you may find yourself using the wrong lenses with a less than satisfactory camera.

Olympus makes a decent camera. It has one advantage in that the camera can take quite long exposures without any special accessories or software — most DSLRs are limited “out of the box” to 30-second exposures. However, at the current time, Olympus sensitivity is not on a par with their competitors.

Nikon has excellent image sensors. Unfortunately the

company has crippled its cameras with what can only be described as poor design practice. The in-camera processor subtracts a number from every pixel to zero the background when converting the image to digital form. Unfortunately, it subtracts “way too much,” resulting in half the pixels of a “dark frame” being negative, and therefore clipped to zero. This degrades the image background — and the sky background is extremely important for astrophotography — and causes major problems with an important step called dark-frame subtraction. There is a workaround to trick these cameras into aborting this subtraction, involving choosing a certain mode and turning off the camera while the image is being processed, but it is a bit of a kludge. In addition, Nikon makes it extremely difficult for software providers to get access to its “API (Application Programming Interface).” In some cases, the API does not even work properly. For these reasons, even though many people swear by them, I cannot recommend Nikon cameras at this time. That said, the D40, D50, and D70 models are Nikon’s best for astrophotography and also its cheapest models.

Canon is clearly the current leader in DSLRs for astrophotography. Their sensors are very sensitive, they make their API readily available, and the cameras generally work well. The Canon EOS 20D, 30D, Rebel XT, and Rebel XTi are all excellent for astrophotography and are highly recommended.

In the next installment, we will talk about using the cameras, and some of the pitfalls. ●

*Doug George is President of Diffraction Limited, an Ottawa-based company that produces astronomical imaging products including MaxIm DL and MaxDSLR. In addition to engaging in astrophotography and observing occultations, he enjoys participating in patrol programs. He has co-discovered a comet visually and co-discovered 12 supernovae as a member of the Puckett Observatory Supernova Search team. Doug is also a Past President of the RASC.*

## RASC INTERNET RESOURCES



**Visit the RASC Web site**  
[www.rasc.ca](http://www.rasc.ca)

**Renew your Membership**  
[www.store.rasc.ca](http://www.store.rasc.ca)

**Contact the National Office**  
[nationaloffice@rasc.ca](mailto:nationaloffice@rasc.ca)



### Join the RASC's email Discussion List

The RASCals list is a forum for discussion among members of the RASC. The forum encourages communication among members across the country and beyond. It began in November 1995 and currently has about 300 members.

To join the list, send an email to [listserv@ap.stmarys.ca](mailto:listserv@ap.stmarys.ca) with the words “subscribe rascals Your Name (Your Centre)” as the first line of the message. For further information see: [www.rasc.ca/computer/rasclist.htm](http://www.rasc.ca/computer/rasclist.htm)

# “What is a Planet?”

by Leslie J. Sage ([l.sage@naturedc.com](mailto:l.sage@naturedc.com))

There has been a lot of fuss recently about Pluto’s reclassification (which I strongly endorse), but that fuss has obscured the more difficult issue of just how one defines a planet. There has also been a lot of criticism of the IAU definition, and even more of the process by which the current definition was arrived at and voted upon, so let us take a few minutes to explore why defining a planet is so difficult. In fact, if you go to (almost) any astronomy textbook you will not find a definition for a planet! This absence reflects history; we thought we knew what a planet was just by seeing it.

From 1930 until 1992, we had nine planets, and although Pluto was tiny and in a strange orbit, there was no serious and widespread questioning of its status. That perception changed when the first Kuiper belt objects (KBOs) were discovered, because it rapidly became apparent that Pluto was in fact simply a large member of the Kuiper belt, which is an extended region of Solar System leftovers beyond the orbit of Neptune. But Pluto was bigger than any of the first-discovered KBOs, so the question of defining a planet could still be put off, with the general idea that perhaps Pluto could be defined as an honorary planet and used to establish the lower bound.

In the mid 1990s, two discoveries occurred that nudged astronomers closer to having to define a planet: the first brown dwarf was identified (November 30, 1995 issue of *Nature*), and the first planet orbiting another normal star was discovered (November 23, 1995 issue of *Nature*). A brown dwarf occupies the nebulous middle ground between a planet and a star — early in its life it can fuse deuterium in its core, but it never achieves the self-sustaining nuclear fusion that defines a star. This state corresponds roughly to masses between about 13 and 75 Jupiter masses. You would think that this distinction would make defining a planet easy, right? It is less than 13 Jupiter masses. But it turns out that there is a population of objects — with masses between about 5 and 15 Jupiter masses — that are not orbiting stars. Rather, they are simply floating freely in clusters of newly formed stars. Are they planets? They occupy a mass range where they could reasonably be called such, but they are not orbiting a star. Hmm, this is getting tricky. Could we define a planet to be a body orbiting a star, too small to fuse deuterium, and (say) about Pluto’s size or bigger?

Astronomers grappled with these ideas for the best part of ten years before the infamous IAU meeting in August 2006. Several committees were unable to reach a definition with which everyone was happy. Then in 2004 two large KBOs were discovered, one of which — originally designated 2003 UB<sub>313</sub>, now known as Eris — is

about the same size as Pluto. Now the situation got very tricky for the IAU. They had dodged the definition previously, but different committees are responsible for the naming of planets and minor bodies (and those committees use different conventions), so they were forced to reach some kind of conclusion that would allow the new KBOs to be named.

In its favour, the IAU tried to be very inclusive in setting up the committee that would be forced to reach a decision — it contained a journalist, an author, an historian of astronomy, as well as prominent people from the planetary and astronomy communities. The problem was, all possible definitions had already been tried and discarded. The committee reached a compromise they thought would be acceptable, by picking the physically reasonable and rigorous criterion that the body had to be big enough such that its self-gravity would make it into a sphere. But while the intent was good, it had the practical drawbacks that it redefined Ceres and Charon (Pluto’s moon) to be “dwarf planets” and left completely open-ended the total number of planets in the Solar System. Further, the status of some future large and distant KBOs might be uncertain for many years until it could be determined whether they were spherical. *Nature* endorsed this definition in the misguided (in my opinion) belief that a specific definition would stop the debate (see the August 17, 2006 issue of *Nature*). The definition was immediately shot down at the IAU meeting (for an entertaining blog on what transpired see <http://tinyurl.com/ybzp98>). The motivation for the spherical criterion was to use physics in a rigorous way and let the Solar System describe itself back to us without any inherent bias or judgment. However, it was on this point that emotion clashed with physics, and tempers flared.

The ultimate compromise approved at the meeting, but sure to be revisited at the next IAU general assembly in 2009, involved adding a new criterion: a planet had to have cleared its neighbourhood, which excluded Ceres, Pluto, and the other KBOs from being planets. This criterion, ultimately, is unsatisfying because “clearing its neighbourhood” is inherently subjective. Has Neptune truly cleared its neighbourhood? Pluto is in a resonant orbit with Neptune, so a reasonable case could be made that Neptune does not fulfill that criterion.

The adopted definition is very unsatisfactory, but it at least enabled the IAU to make a decision. A colleague of mine at *Nature* came up with perhaps the most insightful comment I have heard on the topic: he likened a planet to a fish. In biology, “fish” is not an official designation, but you recognize a fish when you see one. In

the same way, one recognizes a planet when you see one. Pluto is not a planet, because it is part of the Kuiper belt population. Mercury, though very small, is a planet. Of course, if you judge strictly by population membership, what would happen if we found a Jupiter-sized body in the Kuiper belt? Admittedly, that is very unlikely, but what about a Mars-sized body, which cannot be ruled out? Would you recognize that as a planet, or just an extra-big chunk of leftover stuff? I do not know, though my personal preference would be for the latter.

Astronomers generally find this debate rather tedious, because it is simply a matter of the terminology in the field lagging behind the science and because a body is either interesting or uninteresting in its own right. The terminology problem happens all the time. I remember that soon after I joined *Nature* I had a rather tense discussion with an author who wanted to use the term “quasi-stellar object” to refer to a quasar, making the point that that was the designation used by optical astronomers. Radio astronomers used “quasar.” I finally won the argument because the underlying physical phenomenon — gas falling onto a supermassive black hole at the centre of a galaxy — was not in dispute, but it was another instance

of science leaping ahead of the words we used, so for clarity one term should be agreed upon (and quasar had at that point obviously won).

When I teach introductory astronomy or visit science classes in schools, I always start with a little demonstration that underscores to the students that simply being able to hang a label on something does not mean you understand it. And here is a challenge to any readers who are teachers: ask your students to define a planet, and then see where that exercise gets you, not just in terms of the different definitions but also the contradictions and puzzling counter-examples that result. I am sure that the definition of a planet will evolve with time, as our understanding of the Universe evolves. ●

*Leslie J. Sage is Senior Editor, Physical Science (Astronomy) for Nature Magazine and a Research Associate in the Astronomy Department at the University of Maryland. He grew up in Burlington, Ontario, where even the bright lights of Toronto did not dim his enthusiasm for astronomy. Currently he studies molecular gas and star formation in galaxies, particularly interacting ones, but is not above looking at a humble planetary object.*

---

## Deep-Sky Contemplations

---

# Hubble's Variable Nebula

by Warren Finlay ([warren.finlay@interbaun.com](mailto:warren.finlay@interbaun.com)) and Doug Hube ([jdhube@telus.net](mailto:jdhube@telus.net)) Edmonton Centre

Imagine continuously spraying an aerosol can with your left hand. Now imagine taking a can of bottled air with your right hand and continuously releasing a jet of co-flowing air within the aerosol spray to create a hollow volume inside the aerosol spray. Take a moment to make sure you have this visualized. Now imagine it is dark while you are performing this experiment, and a friend directs a small white light along the air jet into the hollowed-out region of the spray to light up the inside of the spray. Now imagine there are swarms of mosquitoes flying about and some of these fly in front of your friend's flashlight before getting blown into the spray by your bottled air. Finally, imagine you are a bystander looking from the side at this strange spectacle. You might at first wonder what the two crazy people with aerosol cans are doing, but after this initial thought, what would you see? Certainly, you would see light scattering off the inside of the aerosol spray, producing a light cone. But you would also see flickering shadows of the mosquitoes whenever they are just in front of the light, with the shadows dancing about the inside of the spray cone like random shadow puppets. Strange as this may seem, if you replace the flashlight with starlight from the star R Monocerotis (R Mon), the bottled air with a fast stellar wind from R Mon, and the mosquitoes with dust streamers ejected from the disk and

nearby dust envelope of R Mon, the result is NGC 2261 [RA(2000) = 06<sup>h</sup> 39.2<sup>m</sup>, DEC(2000) = +08° 45′], a reflection nebula in Monoceros.

Although William Herschel did not have access to pressurized aerosol cans to help visualize what he was seeing, he was the

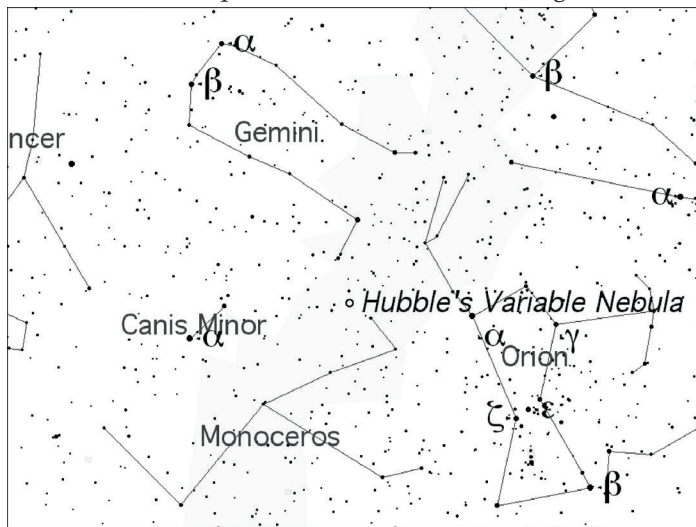

Figure 1 — Position of NGC 2261 (Hubble's Variable Nebula) in the night sky.

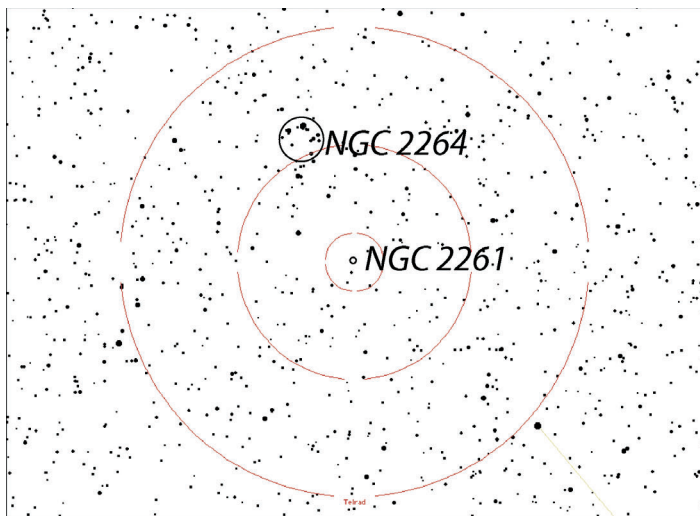

Figure 2 — Finder chart for NGC 2261 and NGC 2264 shown with 0.5°, 2°, and 4° Telrad circles.

first to observe NGC 2261. It was not until 1915 that John Mellish, an amateur astronomer volunteering at Yerkes, noted the changing appearance of this object, causing him to mistake it for a comet. A then unknown first-year graduate student at Yerkes, the now famous Edwin Hubble, was given the job of determining the variability of NGC 2261, leading to Hubble's first archival journal paper in 1916 and the eventual naming of this object as "Hubble's Variable Nebula."

NGC 2261 is a small object ( $2' \times 1'$ ) but is relatively bright (mag. 10) and easily seen in a 4-inch scope. At a distance of 2500 light years, it is approximately a light year across. Its fan-like appearance is due to light from R Mon scattering off the

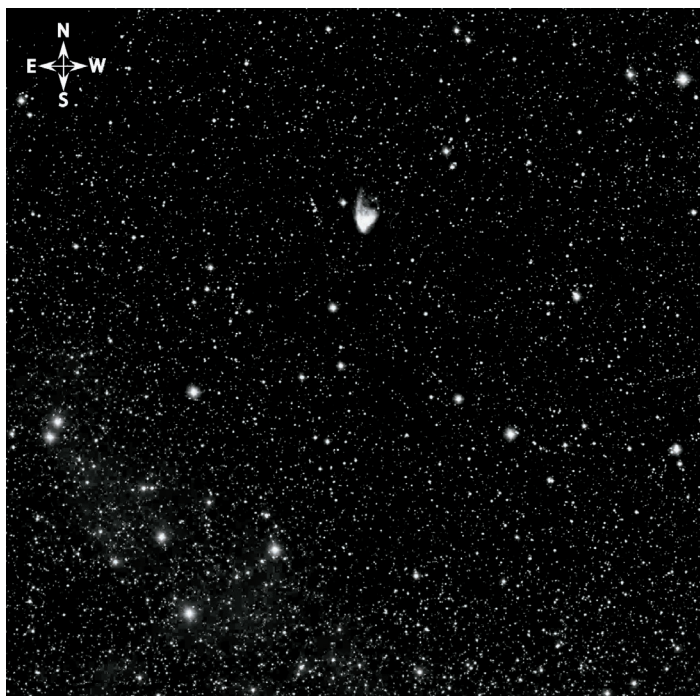

Figure 3 — 50'  $\times$  50' POSS image of the field that includes NGC 2261. NGC 2261 lies somewhat north of centre in this image due to a flaw in the original POSS image.



Figure 4 — Image of NGC 2261 courtesy of Carole Westphal/Adam Block/NOAO/AURA/NSF.

inside of a hollowed out, goblet-shaped region of dust. R Mon is actually immersed in a circumstellar disk of dust about 100 AU in radius, but a fast wind from R Mon has blown a passageway in this disk so that light from the star can shine directly into the inside of the much larger dust shell that has grown into NGC 2261 immediately north of R Mon. The shell of the dusty bowl that we see from the side as the comet-like NGC 2261 has a thickness of about 800 AU. Small rotating dust streamers lying close to R Mon (at a distance of about 2 AU), ejected from the disk and nearby envelope near the star, cast moving shadows on the sides of the bowl, causing NGC 2261 to change in appearance over times as short as three days. Additional shadows, that do not appear to move, are cast by larger dust filaments contained well inside the bowl and give rise to NGC 2261's more-permanent dark features. Professional telescopes also find a mirror-image dust bowl south of R Mon, making the flow of material out of R Mon a bipolar outflow. The southern bowl is not visible at the eyepiece in amateur telescopes.

The star R Mon that lights up NGC 2261 formed only about  $3 \times 10^5$  years ago and is largely obscured by the circumstellar dusty disk that normally surrounds infant stars such as this one. The star has a mass of about 10 Suns and has a less-massive binary companion (1.5 solar masses) that orbits at a distance of 670 AU (0.69") with a period of about 5000 years.

The next few times you are out under a dark sky, note the appearance of NGC 2261 at high magnification and see if you can detect any changes from one observing session to another. Those with CCD cameras can compare images taken on different nights, from which changes in this nebula should be apparent. Indeed, nice animations of CCD images showing the changing appearance can be viewed at several Web sites.

Nearby to NGC 2261 lying approximately a degree North, lies the open cluster NGC 2264 [RA(2000) =  $06^h 41.0^m$ , DEC(2000) =  $+09^\circ 54'$ ]. NGC 2264 is located within about 100 light years of NGC 2261, and may have formed from the same molecular cloud. NGC 2264's nickname as the "Christmas Tree Cluster," arising because of its appearance in the eyepiece, is doubly

appropriate given William Herschel's discovery of its companion NGC 2261 on the day after Christmas in 1764.

### Acknowledgements

DSS/POSS: The Digitized Sky Survey / Palomar Observatory Sky Survey was produced at the Space Telescope Science Institute under US government grant NAG W-2166. The images of these surveys are based upon photographic data obtained using the Oschin Schmidt Telescope on Palomar

Mountain and the UK Schmidt telescope. The plates were processed into the present compressed digital form with the permission of these institutions. ●

*Doug Hube is a professional astronomer retired from the University of Alberta. Warren Finlay is the author of Concise Catalog of Deep-sky Objects: Astrophysical Information for 500 Galaxies, Clusters and Nebulae (Springer, 2003), and is a professor of engineering at the University of Alberta.*

---

## Through My Eyepiece

---

# Starting Out: Buying a Telescope

by Geoff Gaherty, Toronto Centre (geoff@foxmead.ca)

**T**he year 2007 is a very special one for me. It marks the 50th anniversary of my becoming an amateur astronomer and, incidentally, a member of the RASC. I haven't been a member continuously for the last 50 years, but I have been a member for nearly half that time.

When I first joined the RASC, one of the major benefits I received from the Society was the accumulated wisdom of its members. This was shared with great generosity and has forever enriched my life. I've devoted a lot of time since then to helping other beginners get started, so I thought that, as a theme for 2007, I'd use my column to talk directly to our newer members and pass the torch on to them. In this episode, I will talk about telescopes: when, where, and what to buy.

### When to Buy?

Most beginners buy a telescope too soon. As soon as they get interested in astronomy, they head straight to the nearest shopping mall, credit card in hand. Slow down! Ask yourself if you will be able to find anything with your new telescope. That's the number-one mistake most beginners make: they assume they'll just have to point their telescope at the sky and all sorts of celestial wonders will appear. The reality is that the sky is huge, and only a relatively few areas are interesting — you need to know what to point your scope at and how to point it.

Back in 1957, the world was a bit slower. Instead of the Internet, we had something called "mail order." At the beginning of May, when the astronomy bug first bit me, I immediately wrote off to a couple of the advertisers in *Scientific American*. A month later their catalogues arrived. I studied them intensively for a day or two and then mailed off an order for a telescope. A month later, the telescope arrived. Basically I had two whole

months between impulse and satisfaction. Those two months were spent reading everything I could get my hands on about astronomy, and every clear night was spent under the sky, with nothing but my eyes and a 6×30 monocular. When the telescope finally arrived, on July 4, I already had an observing list as long as my arm, so the telescope was put to immediate productive use.

So my first advice is to take your time about getting a telescope. Learn the skies with your naked eyes, possibly enhanced by an inexpensive small binocular, 7×50 or 10×50. I was a 16-year-old kid, so didn't have much in the way of resources, and it was many months more before I discovered the RASC. If you're reading this, you're probably already a member. Make the most of it: get out to your local Centre's star parties, and look through and at as many telescopes as you can. The choices are much more varied today than 50 years ago, and it's possible to fall into "paralysis by analysis," whereby you spend so much time trying to make up your mind on the perfect telescope that you end up never buying one.

### Where to buy?

Back in 1957, I had limited choices. I could buy a telescope at a local department store, but I quickly learned to be leery of the offerings of Simpsons and Eaton's. There actually was a store in Montreal at the time that sold telescopes. This was Harrison's on St. Catherine Street. They primarily sold surveying instruments but had a small display of Japanese refractors, Polarex brand, similar to the Unitrons I saw advertised in the States. However, telescopes were very much a sideline to them, and they definitely weren't friendly towards teenagers — which left the ads in *Scientific American*, primarily Unitron and Edmund Scientific.

When the catalogues arrived, the Unitrons were absolutely gorgeous, except that all but their low-end 40-mm refractor were outside my budget. The Edmund catalogue was more promising — in fact it was an absolute delight to a 16-year-old geek. I found that I could actually afford their second-smallest scope, and that's what I wrote away for.

Today there are still the department stores, camera stores, and nature stores — best avoided. We are blessed with a remarkable number of Canadian telescope stores, most of which operate e-stores as well as traditional storefront operations. Then there are the U.S. dealers, also after our Canadian business. If you have a local telescope store, that would be my first recommendation. These are all run by dedicated people really interested in earning your business and keeping it. If you're far from a walk-in store, then use the Internet. The competition is pretty fierce, so you probably won't find much difference in price. Ask around among your astronomer friends, and find out whom they've had good dealings with.

### What to Buy?

This is where the writer traditionally describes the different kinds of telescopes, mounts, and accessories, and provides supposedly unbiased accounts of the pros and cons of each. I'm not going to do that. You're seriously interested in astronomy. That means you want the most aperture you can afford and transport. Unless you're blessed with dark skies where you live (most of us aren't), you're going to have to travel to a darker location pretty regularly if you want to observe much other than the Sun, Moon, and planets. For me, that makes the choice of telescope simple: get the biggest Dobsonian reflector you can afford and transport. If you visit my Web site ([www.gaherty.ca](http://www.gaherty.ca)), you'll see that I've owned a couple of dozen telescopes of all sizes and vintages. On any given evening, I usually have a choice of at least half a dozen scopes. Nine times out of ten, I'll choose

the biggest one available. My favourite size is around 250-mm aperture. These typically have the same focal length as smaller scopes, around 1200 to 1250 mm. This is the size I've found perfect for comfortable "sit-down" observing. Observing while comfortably seated at the eyepiece will normally allow you to see objects about a magnitude fainter than if you're standing up.

I recommend Dobsonians because I find the Dobsonian mount the easiest to use and also the lightest in weight - that portability factor again. I don't do much imaging myself, and I also recommend that beginners put off any thoughts of imaging for at least a year or so. There's just so much to learn in your early days in astronomy as it is without the added complications of photography. Chances are, if and when you get around to imaging, you will have quite a different telescope in mind for that purpose.

As I indicated in my last column, I've recently become a convert to digital setting circles, though I'm still not convinced that they are the best way to get started in astronomy. An argument can be made for them if you're forced to do most of your observing under light-polluted skies. However, a better solution is to try to get out under really dark skies as often as you can.

The eyepieces supplied with most telescopes nowadays are generally pretty good, a big improvement since the 1950s. There are now excellent clones of premium wide-field eyepieces becoming available at much more affordable prices. Again, members of your Centre or your local dealer are good sources of advice on eyepiece choice.

Next time I'll talk about how to use your scope and what to look at on your first night out. ●

*Geoff Gaherty started out as a teen when he joined the RASC in 1957. Now he's semi-retired but still enjoying his hobby in various ways — one is sharing his accumulated wisdom as a specialist for Starry Night Customer Support.*

### HELP WANTED

The *Journal* is not a single-person production. It requires writers, photographers, artists, poets, night-seekers, designers, women, proofreaders, and editors — in short, a Universe of skills.

Do you know a compound adjective from an adverb? Recognize a dangling participle? Do you find *Eats, Shoots & Leaves* to be a bit redundant? Perhaps you taught English? Is there a writing reference under the Christmas tree for you? If you can answer "yes" to some of these, the *Journal* needs you to take some of the pressures off of our current dedicated proofreaders. Time: about two hours every two months.

Perhaps commas and semi-colons are not your favourite bedtime companions (though you know how to put them in their places), but instead flow of words in well-written prose. Your senses were offended by an ugly turn of phrase in the paragraph above? Do you have a wide-ranging knowledge of astronomy, to check facts and suggest words? Then perhaps a stint as an editor is more to your liking — reading what others have written and helping them and us with the clarity and flow.

Apply in writing (an email) to the Editor ([editor@rasc.ca](mailto:editor@rasc.ca)) and we'll put you to the test. Ability to work to a (very short) deadline is an asset.



## Rings and Things

by Don Van Akker, Victoria Centre ([don@knappett.com](mailto:don@knappett.com))

This ring assembly was made to hold the finder scope described in the last issue but it can be used with any finder. Just change the size of the components as required, keeping things in about the same proportions.

The rings are  $\frac{3}{4}$ " slices of 3" ABS pipe. To mark your cut lines, wrap a sheet of card stock (like a file folder) around the pipe. When the edges align, run a pencil around to make a cut line that is perfectly square to the pipe. Cut with any fine tooth saw (a hacksaw is great) and be fussy. Keep slicing from the end of the pipe until you get two nice even rings plus a third to practice on. Dress the cut edges on a piece of fine sandpaper (280 grit is good) taped to a flat surface like your countertop. Pretend you're polishing the counter with the ring until all saw marks have been sanded away.

Drilling the three  $\frac{5}{32}$ " holes equidistant, on the radius line, and square is a bit of a challenge but if you don't get it right the centring bolts have a snaggletooth effect that will immediately tell everyone you made this yourself.

Start by wrapping  $\frac{3}{4}$ " masking tape completely around one of the rings and double cutting the overlap so you get a perfect end butt. Then carefully peel off the tape and stick it to the counter. The length of the tape is now precisely the same as the circumference of the ring so very carefully, with a tape measure or ruler and a sharp pencil, divide the tape length in thirds and mark. Now divide it in half width-wise and mark the centre for the mounting bolt. Wrap the tape around the ring again and on each mark and at the joint, using something pointy and sharp like an awl, make a dimple in the plastic beneath. You can do both rings with the same piece of tape.

Drilling is best done with an electric drill laid flat on the counter. Mine wobbled,

but taping a small nut under one end made it lie flat. The drill bit wasn't quite parallel to the counter but moving the nut slightly got it just right. Drills are all different so you will have to experiment. Lay one of your rings flat on the counter and put magazines under it so that the dimples are at exactly the height of the drill bit. Drill a few holes in your practice ring and when you have the feel of it drill a hole through each dimple on your good rings. Slow and steady here. Your bit was made to drill easily into wood and metal. It drills even more easily into fingers.

The 10-24 mounting bolts (that's #10 diameter and 24 threads per inch) can be turned directly into the holes and will cut their own thread into the plastic. This is better than cutting the thread with a tap because there is no slop and the bolts fit tightly. Use a little cooking oil to make this easier.

It was a problem to make a simple and inexpensive base bracket that could be easily removed or replaced and still remain bang on registration every time. All those of you with basement machine shops who can quickly knock off a finely machined

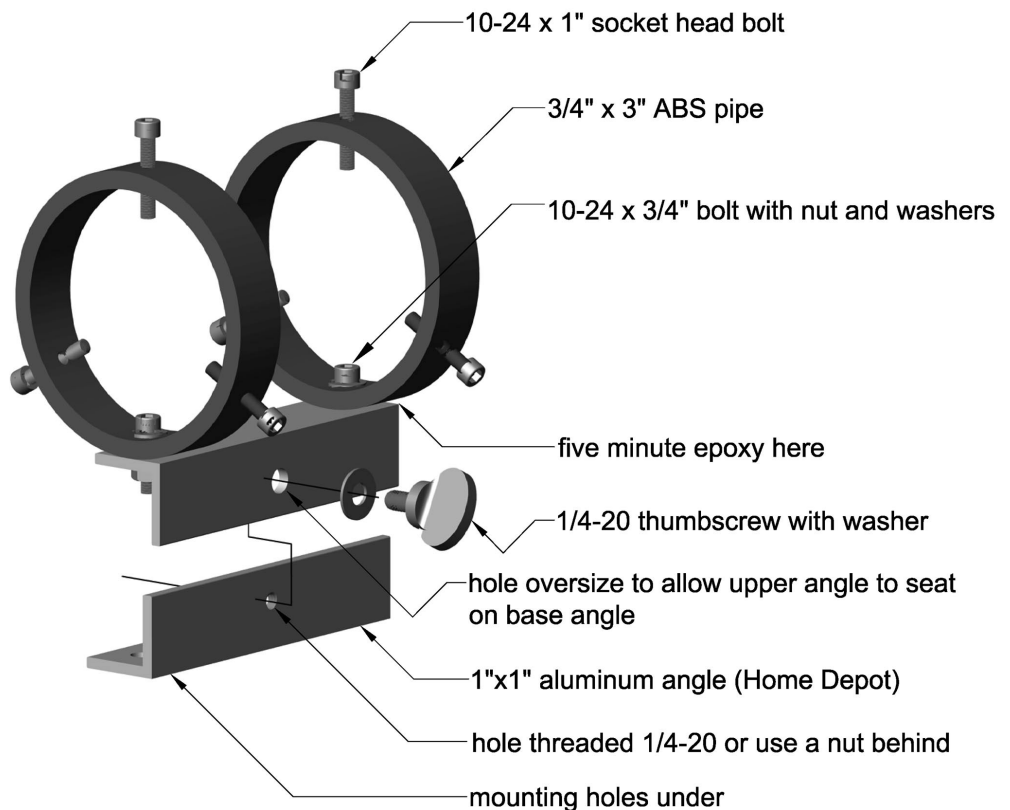

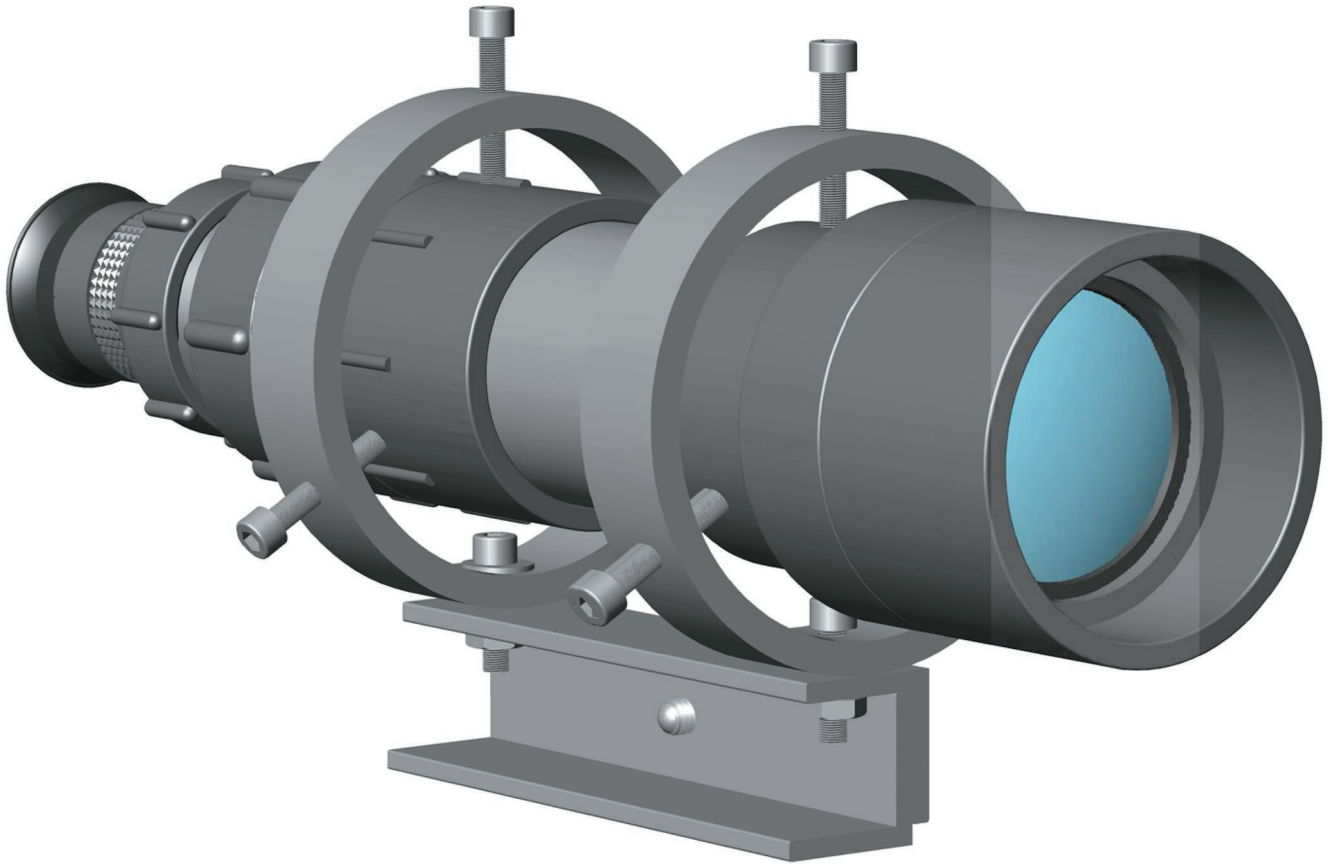

dovetail bracket, please go and do so now.

The rest of us can achieve almost the same results with two pieces of one-inch aluminium angle bar (Home Depot). The base angle is bolted to the main scope. If you don't like the thought of drilling holes in your tube (a really bad idea anyway on anything but a Dob), I have had good results just gluing it down with silicone. Silicone the face, tape it down until it dries, then mask with tape and run a bead around the perimeter — just like caulking your bathtub. A better option, especially on an SCT, is to make the lower angle long enough to catch the mounting holes on your main scope.

The tube rings are mounted on the upper angle, each with a small bolt, but with the addition of a little dab of five-minute epoxy. This solves the problem of mating a round surface to a flat surface by forming a small saddle that cradles the ring.

Assemble everything as shown and mount it on your scope. Use the adjustment bolts to align the finder and go look at some stars.

This and the photocopier finder scope were a great project, so thanks again to Norm Willey for showing us how. Thanks also to John McDonald of the Victoria Centre who took it one step further and actually made a right angle finder by introducing a binocular prism in a pipe elbow behind the eyepiece holder. There's not enough space to keep my promise about the crosshair eyepiece so we'll do that next issue. ●

*Don and Elizabeth Van Akker are members of the Victoria Centre. They observe from Salt Spring Island. Don will answer questions sent to don@knappett.com.*

# Dr. Alexander Jones

by Philip Mozel, Mississauga Centre ([phil.mozel@sympatico.ca](mailto:phil.mozel@sympatico.ca))

Astronomy being one of my major interests (of course!), along with history, it wasn't long before I became fascinated with the history of astronomy. Similarly, Dr. Alexander Jones developed an early interest in science and math — but obtained an Honours Classics degree at the University of British Columbia. In grad school, he discovered he could pursue all these interests and went on to earn his doctorate in the history of mathematics at Brown University. Dr. Jones is currently a Professor in the Department of Classics and in the Institute for the History and Philosophy of Science and Technology at the University of Toronto. In particular, he finds the history of early mathematics and observational astronomy a rich field for research.

Dr. Jones opens our eyes to ancient skies by, in part, sifting through treasure offered up by desert sand. This is where Oxyrhynchus, a town in the desert of Egypt, comes in. A prosperous regional capital in ancient times, Oxyrhynchus was a crossroads of Egyptian, Greek, and Roman culture. It disappeared in the seventh century AD, buried under the Sahara. Remaining lost for more than a millennium, it was discovered and excavated by archaeologists beginning in 1896. Over the years since then, Oxyrhynchus became famous for one feature over all others: the garbage its occupants had hauled to the edge of town and dumped.

But what garbage it is! Burial in the dry sand preserved hundreds of thousands of papyrus fragments: ancient writings scribed centuries ago. Not only are court records, tax information, petitions, leases, bills, and private letters preserved, but also literary fragments from Pindar, Sappho, Euripides, and Sophocles. A century of research on the fruits of early excavation has not yet exhausted this vast trove of information.

Not surprisingly, given the great age of the papyri, much of the writing is not very legible for one reason or another. Here, the space age intrudes. Using multispectral imaging techniques developed for astronomical applications, scientists are able to make the almost invisible ink appear and they can read what would otherwise be forever lost.

A small fraction of the papyri (which still adds up to a lot!) is astronomical in nature. The ancient documents provide a window on what ancient astronomers, Greeks in particular, were doing thousands of years ago, and give us insight into the different astronomical theories and practices current in the distant past. There is much here that Dr. Jones has spent years



Dr. Alexander Jones

studying, such as texts on predicting lunar eclipses, the motions of the Sun, Moon, and planets, syzygies, zodiacal signs, horoscopes, and the works of Ptolemy.

Some of Dr. Jones' work can be accomplished by studying the ancient Greek texts in translation but "One really needs to work with the originals." This does take a bit more time and effort because, language issues aside, the vagaries of ancient penmanship must be dealt with! Nonetheless, "It is a nice feeling to work with ancient material."

Much of our knowledge concerning antiquity actually comes from medieval times whose copyists preserved ancient works that might otherwise have vanished. For example, they passed along considerable information of a medical nature.

However, much of what the copyists worked with were general texts, as is largely the situation with astronomical subjects. Ptolemy's works are a case in point. By reading ancient papyri, Dr. Jones is discovering the details of how ancient astronomers perceived the sky and how they theorized about its motions. The papyri allow him to get the story from as near the "horse's mouth" as possible. Having found, read, translated, transcribed, studied, and evaluated the papyri, Dr. Jones edits and publishes them under such titles as *Omens From the Rising of Sirius*, *Horoscope in Tabular Form*, *Astrological Forecasts of the Rise of the Nile*, *On the Qualities of the Zodiacal Signs*, and *Astrological Forecasts*. (Readers are invited to try reading the papyri themselves by going to the Oxyrhynchus Papyri Web site at [www.papyrology.ox.ac.uk/POxy](http://www.papyrology.ox.ac.uk/POxy))

Research of this kind is not simply a matter of uncovering the deep, ancient roots of modern astronomy. Dr. Jones explains that the very way in which the sky was observed and interpreted, the mathematical tools applied to solve astronomical problems, and the goals of the astronomers, all differed from the approach used today. Therefore, the view provided by modern astronomy is of little help in uncovering the past. In fact, Dr. Jones says that today's historical researchers are mostly on their own simply because the astronomy of antiquity is based on very different principles. One needs to learn ancient astronomy from the ground up.

Dr. Jones enlightened me as to some of these ancient perspectives. Ptolemy, for example, believed the sky to be divine (*i.e.* eternal and unchanging), even as he used mathematics to figure out celestial motion. The Mesopotamians, whom Dr. Jones studies as well, also used math to analyze the sky but sought to predict future events on Earth. Their religious view suggested that the gods are sending us messages via the stars, that the sky is a giant message board. I was also straightened out on the Greek perception of the planets. While it is difficult to say what people of the time considered planets to be, they were probably not viewed as gods. Rather, the roving lights represented gods. For example, Mars was the star of Ares, not actually the god of war.

While ancient cultures may have had disparate views of the heavens, they did influence one another. For example, Ptolemy used observations dating back to the Babylonians (who also

developed the portions of the zodiac that have been passed, via the Greeks, to us). This varied and intertwined history is reflected in Dr. Jones' publications such as *Babylonian Lunar Theory in Egypt: Two New Texts, A New Babylonian Model for Jupiter in a Greek Source, An Eleventh-century Manual of Arabo-Byzantine Astronomy, On the Reconstructed Macedonian and Egyptian Lunar Calendars* and, naturally enough, *Two Astronomical Tables From Oxyrhynchus Based on Babylonian Planetary Theory*.

Returning to Ptolemy, many who are interested in astronomy are familiar with his major astronomical work, the *Almagest*. He also wrote the *Geography*, which presents Ptolemy's map of the inhabited world, as he knew it. Furthermore, the book provides instructions, and the latitudes and longitudes for thousands of places, so that anyone can reconstruct his map. In "Ptolemy's Geography, An Annotated Translation of the Theoretical Chapters," Dr. Jones, and his co-author, provide a translation, with extensive notes, of the *Geography*, bringing it to life once again and showing it in its important historical context.

Besides papyri, Dr. Jones also investigates Babylonian thought recorded in cuneiform on clay tablets. Presumably he will continue to ignore the advice in one such text:

Secret tablet of Heaven, exclusive knowledge of the great gods, not for distribution! He may teach it to the son he loves.

To teach it to a scribe from Babylon or a scribe from Borsippa or any other scholar is an abomination to Nabu and Nisaba.

There is a penalty for passing on such secrets:

In poverty and deficiency . . . may the gods kill him with dropsy!

I hope that Dr. Jones is immune from such ancient curses and will stay healthy long enough to bring many more ancient secrets to light! ●

*Philip Mozel is a past librarian of the Society and was the Producer/Educator at the former McLaughlin Planetarium. He is currently an educator at the Ontario Science Centre.*

---

## Pen & Pixel

---



This sequence of eclipse images was taken by Toronto Centre's Adam Clayson in Egypt during the March 29 eclipse. Clayson used a Canon 20Da on a TeleVue 85 refractor with a 0.8x reducer to give a focal length of 480 mm at f/5.6. The left image was a 1/2000th-second exposure, the others were 1/60th-second exposures, all at a 400-ISO setting.

## A Tale of Three Asteroids

by Guy Nason, Toronto Centre ([asteroids@toronto.rasc.ca](mailto:asteroids@toronto.rasc.ca))

*“The universe loves a drama, you know.  
And ladies and gentlemen this is the show.”*

— Paul Simon, *I Don't Believe  
“Surprise”* Album, © 2006

The Universe presented Canadian occultationists with three successful “dramas” last October. On the 3rd, the asteroid (25) Phocaea cast the shadow of a magnitude 8.8 star along a path that crossed northwestern Quebec, eastern Ontario, and the northeastern USA. At least 23 observers recorded the passage, making this one of the most-observed asteroidal occultations in eastern North America in recent years. On the 7th, three observers in central and southwestern Ontario recorded the occultation of a tenth-magnitude star by (31) Euphrosyne. Finally, (88) Thisbe made its presence known to two observers in British Columbia on October 21. Here, then, is *A Tale of Three Asteroids*.

### Phocaea: Drama on Video

This event was, if not the most dramatic of the three occultations, certainly the best-observed. Because this event involved the brightest star that would be occulted in North America in the fall of 2006, the International Occultation Timing Association decided to hold its Annual General Meeting near the shadow path within a few days of the event. This practice is a common one of IOTA, since it serves to increase the number of observers for the occultation, and also encourages attendance at the meeting, especially by local members and others interested in occultations. This time the gathering was held at Mt. Cuba

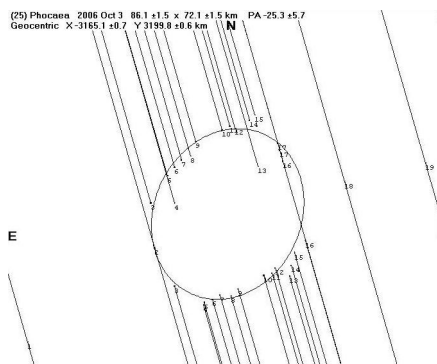
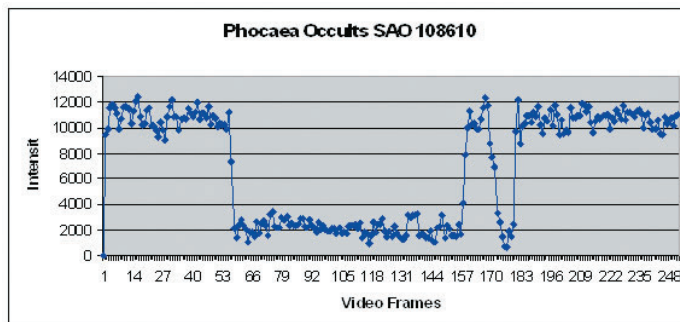

Figure 1 — Shadow outline of (25) Phocaea based on the occultation reports of 19 observers.



Graph 1 — A graph of the grazing occultation of the star SAO 108610 by (25) Phocaea as recorded by Brad Timerson. The peak near frame 160 represents the brief reappearance of the star.

Observatory, a private facility in Greenville, Delaware, on September 30 and October 1, 2006 — the weekend before the Phocaea occultation. I attended the meetings, but decided not to observe the occultation there. Instead, I opted for the ten-hour drive back to my cottage and observatory north of Kingston, Ontario, which lies directly in the predicted path. Seven other Canadian observers at five stations also timed the event. The American contingent included 15 observers at 10 stations, from upstate New York to southern Maryland.

Michael Vasseur in Gatineau, Quebec and Leo Enright in Charbot Lake, Ontario observed misses. Kingston Centre members Brian Hunter, Ken Kingdon, and the “Kingston Trio” team of Arlyne and Lee Gillespie and David Cotterell, timed occultations of 3.6 seconds, 4.4 seconds and 6.3 seconds respectively, from various locations in and around Kingston. I videotaped a 5.8 second occultation near Cloyne, Ontario. The Americans’ times were similar, with one very dramatic exception. Brad Timerson in Newark, New York (near Rochester) video-recorded a double event. That is, the target star disappeared, reappeared, then disappeared and reappeared again. At first he thought he might have discovered a “sateloid” of Phocaea. However, further analysis indicated that it is more likely that he recorded a grazing occultation by asteroid (25) Phocaea, meaning that he was probably right on the edge of the shadow path and the starlight was obstructed twice by irregularities on the limb of the asteroid (Graph 1). On the sky-plane plot, Brad’s chords are numbers 16 and 17. Brad’s hit and Michael Richmond’s miss at nearby R.I.T. in Rochester, together with Leo Enright’s very near miss on the other side of the path, place good constraints on the asteroid’s width — at least as it was presented to us that night (Figure 1).

Speaking for all of us, Ken Kingdon, Observing Chairman of the Kingston Centre, wrote:

The boost in observations [of the Phocaea occultation] by many RASC-KC observers did indeed help *a lot...*[emphasis is Ken's] the best in *many* years in a well-populated region of North America is very remarkable! All of us, including myself, made errors... but like many endeavours, making errors is perfectly acceptable since it is a way to improve technique. Then reliability improves, and gradually, things begin to fall into place. Thanks very kindly to all who helped... All of us who tried had fun and learned something new...and that's the essence of astronomy.

(31) Euphrosyne 2006 Oct 7 233.0 ± 30.0 x 275.0 ± 32.9 km PA -64.0 ± 02.4  
Geocentric X -4630.3 ± 7.0 Y 4104.6 ± 24.0 km N

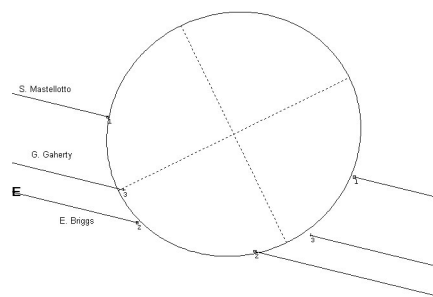

Figure 2 — Shadow outline of (31) Euphrosyne based on three occultation reports.

Phocaea Observer's List		
Chord Name(s)	In or Near	
1	Michael Vasseur	Gatineau, QC
2	Leo Enright	Sharbot Lake, ON
3	Brian Hunter	Kingston, ON
4	Ken Kingdon	Kingston, ON
5	Richard Nugent	Newfield, NJ
6	David Dunham	Elmer, NJ
7	Guy Nason	Cloyne, ON
8	Tom Bash	Jim Thorpe, PA
9	Paul Maley, Greg Lee	Woodstown, NJ
10	Bruce Thompson, Tayza Yeelin	Ithaca, NY
11	John Kmetz, E. Bredner	Pulpit Rock, PA
12	D. Cotterell, Arlyne & Lee Gillespie	Kingston, ON
13	Wayne Warren	Bear, DE
14	Dick Sauder	Narvon, PA
15	Joe Sedlak	Vernon, DE
16, 17	Brad Timerson	Newark, NY
18	Michael Richmond	Rochester, NY
19	Don Gardner	Columbia, MD

### Euphrosyne: Drama Denied

Perhaps because it happened on the Friday night/Saturday morning of the Thanksgiving weekend, the Euphrosyne occultation was recorded by only three observers. As far as I know, Steve Mastellotto at the Windsor Centre's Hallam Observatory, Eric Briggs in Toronto, and Geoff Gaherty near Coldwater, Ontario, were the only ones who witnessed this event, even though its 416 km-wide path crossed directly over the most heavily populated part of Canada. A dozen others were prevented from observing this event by either cloudy skies or a combination of hazy skies and a very bright Harvest Moon. Still, three observers are enough to deduce at least a rough sky-plane plot (Figure 2).

The potential bonus this night was the distinct possibility of observing two different asteroidal occultations within 20 minutes of each other. From a single location, it was theoretically

possible to witness the Euphrosyne occultation in Lynx, then slew the telescope over to Aquarius and watch (119) Althaea blink out an 11.6 magnitude star southeast of the Water Jar. Wrote Steve Mastellotto:

After (the Euphrosyne) event I swung the scope over to Althaea and immediately recognized the field (I found it earlier in the evening) and after about two minutes of setting up, the field started to go blank like it was overexposing. I checked the equipment but there were no problems. Then I looked up at the sky and a bank of clouds had moved over the area. The clouds covered the SE to West horizon to about 60 degrees... so I was clouded out. When I was packing the car and leaving at 2:30 the entire sky was clear again.

Similar fates befell Geoff Gaherty and Eric Briggs. Others in the USA observed misses or were clouded out, so nothing positive came of the Althaea occultation. Too bad. Recording two events in such a short time would have been dramatic, indeed!

### Thisbe: Drama Uncertain

Two weeks later, Alan Whitman and Guy Mackie of the Okanagan Centre, and Steve Preston in Washington state attempted to observe the occultation of a faint (magnitude 12.6) star in Cancer by asteroid (88) Thisbe. Alan observed a clean hit, but not without difficulty. Here's Alan:

Steve Preston [IOTA's master astrometrist] had advised us that lambda Gem would pass through the same part of the sky about 90 minutes before the event. This information was a life-saver {Many thanks, Steve} because Lambda Gem was still behind trees 75 minutes before the event. My neurologist had warned me never to lift anything heavy again for the rest of my life, but the equatorial mount had to be moved again if I was to see the asteroid occultation or else I had to make a quick changeover back to the Dobsonian mount (which probably would have run me out of time). Possible paralysis or miss the event. Well, that's a no-brainer choice, eh? So I picked up the mount more slowly

and carefully this time and moved it about 40 feet west.

The effort was successful and, despite timing difficulties exacerbated by poor radio reception in the Okanagan Valley, Alan reported a duration of 7.5 seconds. The drama for him, besides the excitement of risking serious physical harm, was the step-wise reappearance of the star. In other words, the star returned to its former brightness in two increments, rather than the usual one. Could this have been because the target (the “occulte,” as my friend Jeff Lebold calls it) is a previously unknown binary star? Maybe so, maybe no. Other possible explanations include momentary atmospheric turbulence and a phenomenon known as Fresnel diffraction (which will be explained in a future column.) With only Alan’s observation, we cannot be sure.

Meanwhile, Guy Mackie had dramatics of his own. He saw — well, actually, he is still not sure what he saw. Standing at a rest stop on the Coquihalla Connector (Hwy 97C) west of Kelowna, B.C., Guy saw a flickering of the star at the very time that the occultation was predicted. I’ll let him tell his story.

[I] observed the star from one minute before to one minute after the predicted event time. There was a subtle waver in the light at about the event time but (at the time) I put it down to a distortion caused by my eye, however post-(non-?)event recollection makes me wonder if, due to my lack of experience, the [1.0] mag change was not sufficiently large enough for me to have the confidence to recognize it. At this point I cannot conclusively say that there was not an event, a quite useless observation. ...On reflection, it seemed likely that I had seen the star disappearing and reappearing [repeatedly] while the asteroid remained continuously visible, giving a fluctuating brightness as described. ...I now look back on this event with some satisfaction, actually thrilled, in that serendipity may perhaps have once again saved a lost opportunity as a treasured memory.

Guy certainly has a “treasured memory,” but did he see a grazing asteroidal occultation? Maybe so, maybe no. In his defence, he was plausibly placed, relative to the path, between Alan’s hit and Steve Preston’s clear miss. Also, although new to occultation work, Guy is catching up fast. This is his third success in three months. (I emphasize that, even if he saw a miss, this is still a successful observation, there being none closer.) Besides, he is a very experienced observer, so he has a good understanding of tricks that the eye and the air can play on us. But without a video recording (Guy was using the stop-watch method) or corroboration by another observer, we will never know for sure. Let us call it a definite maybe.

So there you have it, 3 dramas involving 3 asteroids and 13 Canadians in 3 provinces. But what does it all mean? For

one, uncertainties with respect to the asteroids have been reduced. For another, several occultationists now have new “treasured memories.” As with most tales, these three have different meanings for different people. Since we Guys have to stick together, I will leave the last word to the other Guy — Guy Mackie:

Occultation timing has all the usual satisfaction of astronomical observing, combined with the tension and excitement of another *Mission Impossible* re-make and it is a *team* effort [emphasis is Guy’s], making it stand apart from most of our other activities.

Here are some upcoming occultations over populated Canadian territory. As always, please visit [www.asteroidoccultation.com](http://www.asteroidoccultation.com) for more details, finder charts, and other aids, and [www.poyntsource.com/New/index.htm](http://www.poyntsource.com/New/index.htm) for interactive Google maps of the occultation paths. Follow the directions there to determine your site’s offset from the centreline. Please let me know your plans so we can coordinate our observations of these events and avoid duplicating each other’s results. Good luck and clear skies! ●

*Guy Nason is a long-time member of the RASC Toronto Centre and IOTA (International Occultation Timing Association). He has served the Toronto Centre as Observational Activities Coordinator, Councillor, National Council Representative, Secretary, Vice-President, President, and was, until recently, Past President. He received the RASC Service Award in 2004. He has successfully timed several lunar grazes, total occultations, and eight asteroidal occultations.*

\* Notes:

Feb 09: 243 Ida has a “satelloid,” Dactyl, which was discovered by the Galileo spacecraft on its way to Jupiter in August 1993. Watch for a very *short* second event!

Feb 09: The paths for the Ida and Adelaide occultations meet in southern Ontario, but the occultations are ~7h 40m apart (7:40 p.m. est on the 8th and 3:20 a.m. est on the 9th, respectively). This should allow plenty of time to reposition — and warm up — if necessary.

Mar 08 and Mar 13: Varsavia was extremely well observed by more than 80 people in B.C. and down the U.S. Pacific coast in 2003. These are opportunities to get good results on other profiles of the asteroid. Could a 3-D model be the result?

Mar 10: Steinmetz. The star is magnitude 6.6, making this event visible in binoculars. It is 2° WNW from ε Leo.

See Table of Occultations next page...

TABLE OF OCCULTATIONS

Date (2007)	Number	Asteroid Name	Star Magnitude	Change in magnitude	Maximum duration (s)	Location
Feb 1	72	Feronia	12.0	1.3	10.1	NL - QC
Feb 2	510	Mabella	9.3	5.3	4.7	AB - BC
Feb 5	37	Fides	10.6	0.7	14.9	NL - nON
Feb 7	1902	Shaposhnikov1	1.2	4.9	5.4	sON
Feb 8	1540	Kevola	9.2	5.5	4.3	swSK - cBC
Feb 9	243	Ida	10.8	3.1	2.4	NS, NB, sQC, sON*
Feb 9	170	Maria	9.7	4.5	2.1	nSK - sQC
Feb 9	525	Adelaide	10.2	4.7	1.4	ON - nMB*
Feb 11	92	Undina	11.8	0.8	12.8	Vancouver Is.
Feb 12	3054	Strugatskia	10.5	6.0	1.5	Vancouver Is.
Feb 13	3425	Hurukawa	8.6	6.5	2	swON
Feb 14	781	Kartvelia	11.0	3.8	4.6	Atlantic Provs.
Feb 15	4112	Hrabal	8.2	9.0	2.8	nBC
Feb 17	694	Ekard	11.1	3.3	5.6	NS - nMB
Feb 17	2134	Dennispalm	9.4	5.3	1.3	neMB - sw SK
Feb 20	2513	Baetsle	10.2	7.0	1.9	NL - AB
Feb 20	31	Euphrosyne	11.7	0.5	24.4	sON - cBC
Feb 23	5651	Traversa	10.5	6.7	2.1	swBC - nwON
Feb 25	714	Ulula	11.9	1.7	6.9	sQC - NL
Feb 25	5192	Yabuki	9.8	6.3	1.5	seMB - NL
Feb 26	2707	Ueferji	9.6	7.2	2.8	swQC - cON
Mar 2	170	Maria	10.6	3.8	1.6	eQC - wNL
Mar 5	404	Arsinoe	10.3	2.4	15.5	eNS - sBC
Mar 5	2951	Perepadin	11.4	3.0	4.9	nwON - nAB
Mar 8	1579	Herrick	10.1	5.8	5.6	NS - NL
Mar 8	1263	Varsavia	10.2	3.8	3	seON - cBC*
Mar 8	2741	Valdivia	9.8	5.7	2.3	SK
Mar 10	569	Misa	12.0	1.8	6.6	BC
Mar 10	1681	Steinmetz	6.6	8.3	4.3	cMB - seAB*
Mar 12	1487	Boda	10.6	3.8	2.5	sQC - nMB
Mar 13	1263	Varsavia	10.6	3.4	3	seON - nON*
Mar 20	1626	Sadeya	10.5	3.5	7.2	seON - QC
Mar 20	872	Holda	11.4	2.2	3.2	QC
Mar 25	1244	Deira	10.6	3.3	3.7	swQC - eON
Mar 26	498	Tokio	11.1	3.5	5.9	swBC
Apr 3	214	Aschera	10.8	2.9	2.6	seAB - nwBC
Apr 6	777	Gutemberga	11.3	3.4	13	NL
Apr 8	563	Suleika	11.3	1.9	13.4	Vancouver Is. - nwMB
Apr 10	976	Benjamina	11.8	3.2	5.8	sBC



# The Transit of Mercury

by Les Marczi, Hamilton Centre ([lmarczi@cogeco.ca](mailto:lmarczi@cogeco.ca))

**R**ASC members across the country — where weather permitted — were rewarded with a marvellous view of the transit of Mercury across the Sun on November 8. Leslie Marczi from the Niagara Centre found one of those fair-weather spots and provided the following description and image:

After going over the weather patterns in the area at the time, Point Pelee was the only chance we had. The drive from Niagara took us about four hours to get on the

Point. We did have to deal with fog, but got to see the whole thing — well, until the Sun set into a low-lying cloudbank. Niagara Center members Denis Maheu, Ryan Bittle, and I made the trek with a van full of equipment. On arrival, the fog was very thick, but we decided to set up anyway — and it paid off, clearing up somewhat for visual observations at first contact. I then attached cameras and away I went, taking shots when the skies permitted. 🌞

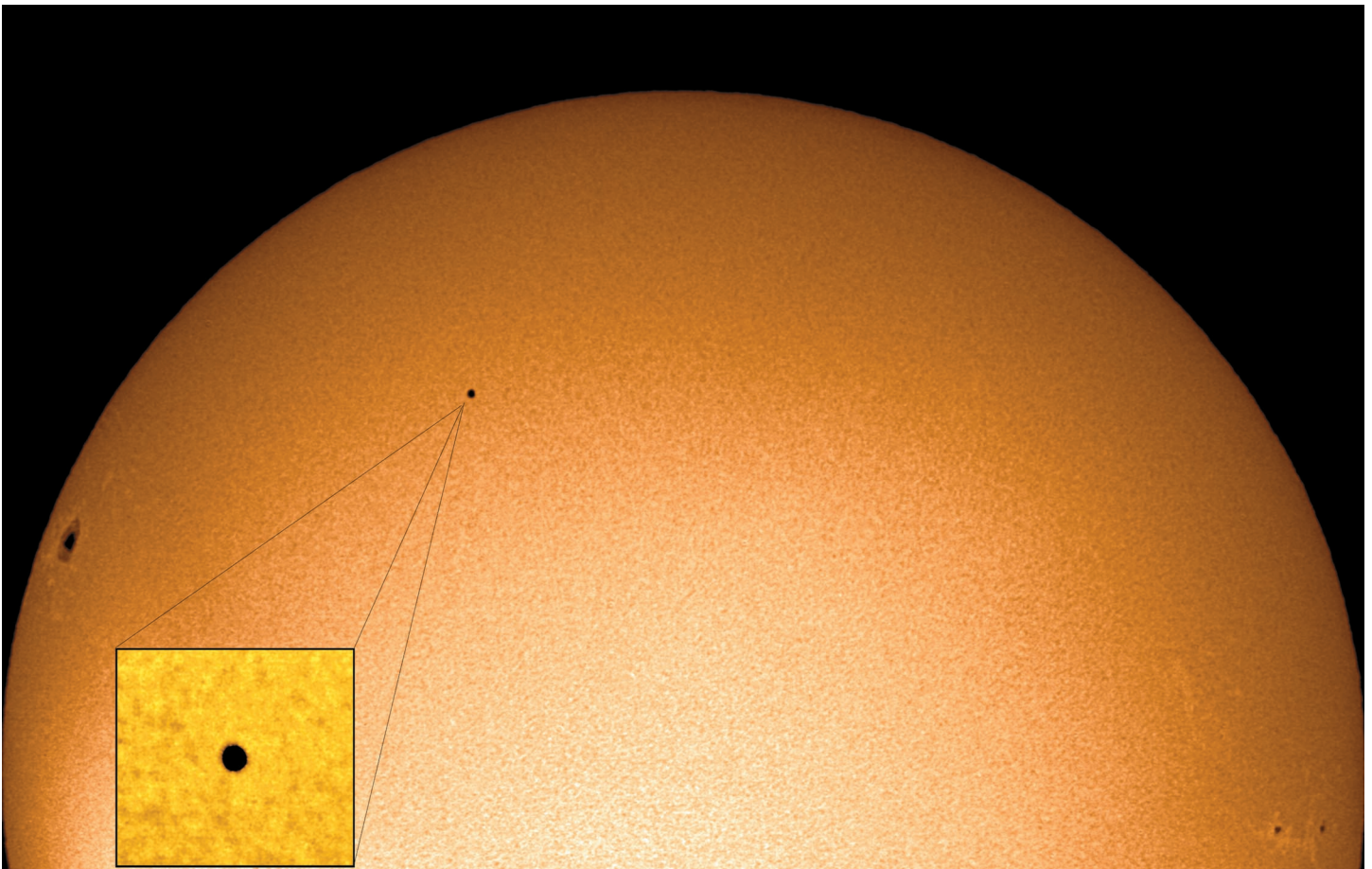

Figure 1 — Image taken by Leslie Marczi with a Celestron 9.25" f/10 SCT and a Canon 300D DSLR through a Baader filter.

# Across the RASC du nouveau dans les Centres

## Calgary Centre Invites RASC Members to General Assembly & Astronomy Roundup 2007

**Y**AHOO! The Calgary Centre is hosting this year's General Assembly of the Royal Astronomical Society of Canada. From June 28 to July 1, we invite you to "come on down" to Calgary, Alberta for a special "Astronomy Roundup 2007." This GA is special because it is being held in conjunction with the American Association of Variable Star Observers' 96th Spring Meeting and the Association of Lunar and Planetary Observers' 60th Annual Meeting. With the theme of "Astronomy in Our Backyards," you can expect to see a wide variety of presentations from members of all three organizations.



All events (except optional tours) will be held on the campus of the University of Calgary. Accompanying family and companions not attending the Astronomy Roundup can easily access Calgary's C-Train system to explore our great city and its many attractions. With the world-renowned Calgary Stampede beginning just days after our Astronomy Roundup, we heartily encourage you to stick around to experience "The Greatest Outdoor Show on Earth." (And did we mention that the beautiful Rocky Mountains are just an hour's drive from Calgary?)

### Speakers

One of the highlights of the Astronomy Roundup will be the Ruth Northcott Public Lecture given by **Ray Villard, News Chief from the Space Telescope Science Institute.** Ray has been with the STScI since 1986 and his talk, entitled "**Hubble Space Telescope's Legacy,**" will cover this incredible instrument's past challenges and scientific accomplishments, as well as its renewed plans for future exploration.



Our Banquet Speaker will be **Dr. Eric Donovan, University of Calgary,** Principal Investigator of the Canadian component of the THEMIS MIDEX program. His group is deploying, operating, and recovering the data from 16 white-light auroral imagers spread across Canada. Eric will show us some beautiful images and explain how the aurora is used as a tool to study things that happen in near-Earth space.

**Dr. Michael Wilson** from Douglas College, Vancouver, will give a talk on astronomy in medicine wheels and **Dr. Tracey Delaney** from the MIT Kavli Institute, Cambridge, will discuss her research on supernovae.

### Planned Workshops

Register for one of the optional Friday morning workshops:

- **Fireball Workshop:** an operational session on how to be a fireball investigator. Includes information on fireball characteristics, instrumental records, meteorite recovery, and case histories.
- **Light-Pollution Abatement Workshop:** symptoms of light pollution, the principles of responsible lighting, and how to advocate responsible lighting.
- **Introduction to Scientific Observing:** an overview of quantitative observing covering visual to instrumented techniques.
- **Imaging Workshop:** covering a broad range of media from sketching to digital astrophotography.

## Optional Tours

On the evening of Thursday, June 28, take a tour of the University's **Rothney Astrophysical Observatory** located south of Calgary. The RAO is home to a 1.8-m-class telescope featuring an alt-alt mount. Also on site is the 0.5-m Baker-Nunn telescope used to hunt for near-Earth asteroids, and a 0.4-m photometry telescope.

After the Astronomy Roundup, the full-day **"Cretaceous/Tertiary Boundary and Tyrrell Museum Badlands"** tour on Monday, July 2, will take you back in time as our guides take you to Dry Island Buffalo Jump Provincial Park to examine the 65-million-year-old K/T boundary. The day wraps up with a visit to the famous Royal Tyrrell Museum of Paleontology and its world-class collection of dinosaur fossils.



The final **"Looking for Mars in the Canadian Rockies"** tour occurs on Tuesday, July 3. It will take you along the Banff-Jasper Icefields Parkway where we'll look at glacial landforms on Earth that shed light on the surface conditions of Mars.

In addition to several members' paper sessions, there will be lots of opportunities to visit with old friends (and make new ones!) at informal get-togethers, a Bison-Burger supper and a traditional Calgary Stampede pancake breakfast.

So mark June 28 to July 3 on your calendar and plan to attend Astronomy Roundup 2007. Don't miss this great opportunity to meet and learn from fellow colleagues in the AAVSO, the ALPO, and the RASC.

## Call for Papers

We invite you to submit a proposal for a paper or a poster to be presented during the Astronomy Roundup 2007. The theme of the conference is "Astronomy in Our Backyards," so presentations describing your observing programs and results are particularly apt. We invite papers and posters from the wide spectrum that is amateur astronomy. The **abstract deadline is March 31**. You will be notified by April 30 if your topic has been accepted as an oral paper or a poster.

Our Web site has up-to-date information regarding paper and poster sessions and how to submit your abstract. Please consider presenting a paper to share your work and inspire your fellow amateur astronomers to follow your lead! ●

## See you in Calgary! Astronomy Roundup 2007 Organizing Committee

Visit the Astronomy Roundup 2007 Web site to register and for more information on accommodations and events.  
<http://calgary.rasc.ca/ar2007>.

---

# Reviews of Publications

## Critiques d'ouvrages

---

**The Cosmic Century: A History of Astrophysics and Cosmology**, by Malcolm Longair, pages 545 + xvi, 18 cm × 25 cm, Cambridge University Press, 2006. Price \$60 US hardcover (ISBN 0-521-4736-1).

*The Cosmic Century* is, of course, the 20th, the most eventful in astronomical history. The book is a scholarly work targeted at serious academics. I lack some of the intellectual enzymes needed to digest the whole thing, but I will try to explain what is offered and what was worthwhile to me.

Visit the following URL to read the table of contents.  
[www.cambridge.org/9780521474368](http://www.cambridge.org/9780521474368).

The preface contains some warnings. An important one is "I have assumed some familiarity with astronomical terminology." Readers who do not recognize terms like *bremstrahlung* or *Rydberg constant* will have to look some things up. Longair anticipated that; he offers the names of three astronomical

encyclopedias that should help.

A lengthy list of references (57 pages) is an indication of the scope of *The Cosmic Century*. Longair has boiled down the life's work of a century of scholars from many disciplines until what remains are what he believes are the most important publications of about a thousand men and women.

Ten of the 16 chapters include explanatory supplements. They are provided "where a little simple mathematics can make the arguments more convincing for the enthusiast." A couple of undergraduate math courses do not make a person an "enthusiast." The supplements are accessible, to even a modest degree, only to readers who have taken enough university mathematics to at least recognize a differential equation.

The book is semi-chronological in a somewhat quirky way. The first two parts are devoted to the pre-1939 era. Part I traces what was understood about the nature and evolution of stars

before WWII. Part II revisits the same period and deals with the discovery that spiral galaxies are island universes and the cosmological implications of relativity.

Part III is about tools and techniques — a century of evolution of every type of astronomical data gathering. The story backtracks to the 19th century, to the seminal discoveries in radioactivity that led to a burgeoning of cosmic-ray research from about 1900. The author proceeds to the most important development of the century, the expansion of observations into every region of the electromagnetic spectrum. Other rather exotic fields such as gravity waves are also visited. Each of the threads is taken up again in its astrophysical context in the remainder of the book.

The final two parts of the book deal with the period from the end of the war to the present. Again, scale is the discriminator. Part IV deals with the astrophysics of stars and galaxies. Here, as in other places, I had the chance to compare my popular-press notions with best current opinion on some issues. Gravity waves are a case in point. I was aware that no one has directly detected them as yet, but I also learned that “it is generally assumed” that the gradual decrease in the orbital period of the binary neutron star system PSR 1913+16 leaves little doubt that the explanation for the decrease is that the system is emitting gravity waves.

The topic of Part V is astrophysical cosmology. An important part of its focus is the development of a supportable theory for the origin of the large-scale structure of the Universe. Progress along that path is driven by successive improvements in the determination of the fundamental cosmological parameters. As the parameter values are measured more precisely, only the fittest structure models survive. The latest word on these values at the time of press was contained in Tegmark’s 2004 publication of a table of derived values. Unprecedented precision was achieved in this table by reconciling data from the Wilkinson Microwave Anisotropy Probe and the Sloan Digital Sky Survey (WMAP/SDSS).

Why do we have galaxy clusters and superclusters and sheets and voids? In 1997 the chief competing theories were standard cold dark matter (SCDM), open cold dark matter (OCDM), cold dark matter with a finite cosmological constant ( $\Lambda$ CDM), and cold dark matter with decaying neutrinos ( $\tau$  CDM). One dividend of the WMAP/SDSS data is powerful support for one of these structure theories — but I will not spoil this section of the book for you except to note that part of the story involves Einstein’s conviction that he had made a colossal blunder, which, in the light of current discoveries, might prove to be correct.

The final chapter (The Very Early Universe) has a different tone from those that precede it and is the one I found the most interesting. Chapter 16 is not history at all; it is the author’s cosmological to-do list for the 21st century. After stating the outstanding problems, Longair offers and analyzes five possible approaches to tackling them.

My hunch is that Longair arranged his approaches to begin with the one he deemed least worthwhile, and to end with his favourite. Since the items at the top of the problem list are ones

listed in Alan Guth’s 1997 book *The Inflationary Universe*, I am not surprised that inflation is one of the candidates. “The inflationary scenario for the early Universe can be adopted and its consequences studied” is third, coming right after the anthropic cosmological principle.

Although it does not appear to be Longair’s favourite, I found that inflation theory was most interesting because of its current prominence in magazines and journals. Longair’s treatment begins by describing it as the “...most important conceptual development for studies of the very early Universe...” but then adds little else, leaving this reviewer wondering why? After tallying up its shortcomings, his final word on the concept is a footnote recommending “a healthily skeptical attitude to the concept of inflation.”

*The Cosmic Century* is a valuable reference for professionals, yet it also contains much of interest for ambitious readers who usually rely upon the Discovery Channel to keep themselves informed.

— JIM KINNAIRD

*Jim Kinnaird is a leader of a section of the RASC Calgary Centre Youth Group. He enjoys the challenge of discussing astronomy and physics with kids who are as excited about learning as he is.*

.....  
**Solar System Observer’s Guide**, by Peter Grego, pages 256, 13 cm × 20 cm, Firefly Books Ltd., 2006. Price \$17.95 softcover (ISBN 1554071321).

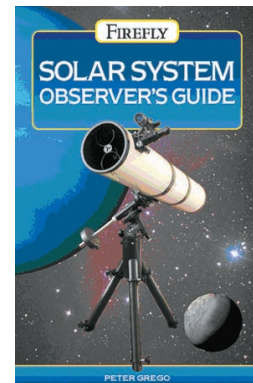

Being a planetary-observing enthusiast, I eagerly accepted a friend’s request to review the latest publication from Firefly Books dedicated to the subject. Aptly titled *Solar System Observer’s Guide*, the book is intended to assist visual exploration of the planets. However even amateurs solely interested in planetary imaging will find much useful information in its pages, though it is written in the spirit of visual planetary study. That spirit is conveyed right from the front cover photograph — an equatorially mounted 20-cm Newtonian reflector telescope, with a curved-vane secondary holder and a lower-profile Crayford focuser, an ideal visual planetary instrument.

I must admit that I have been a big fan of the uncomplicated beauty of visual planetary study from the first time that I saw our Solar System’s gas giants through an eyepiece. As such, I feel I can relate to the author’s direction. Limited information is given to Webcam and other forms of imaging. Instead, Grego describes the pleasure and value of sketching at the eyepiece. He includes some very well-done sketches and encourages readers to try their own hand at it. His reasons for taking the trouble to draw the planets are presented in Chapter 2:

...why go to the trouble of spending an hour or two observing and drawing astronomical objects when the CCD can apparently capture it all with great accuracy in a fraction of a second? Why observe at all, when images captured by a CCD will bring the scene live to one's computer screen indoors? These are great questions, but they are asked only by those who don't get a thrill from seeing the heavens for real.

I can hardly argue the point. After all, is that not why we all got into astronomy in the first place?

The book begins with a basic understanding of where our Solar System is within our Galaxy, and moves on to describe the motion of the inferior and superior planets relative to Earth's orbit. A brief introduction to each planet is given to whet one's appetite for the more detailed information offered in later chapters. Chapter 2 deals with the tools necessary for planetary observers — from an understanding of how we see to telescope and accessory selection. An unfortunate omission is the Maksutov Newtonian telescope. It is a fine instrument for visual observing, but is not described anywhere in the text, appearing only in a photograph. Another omission, especially for visual work, is the use of binoculars.

What the author does present well is a discussion on telescope resolving power and limiting magnitudes for various apertures to the corresponding sizes of lunar features and planetary objects detectable. For example, resolving power is linked to detection of appropriate-sized lunar craters, while limiting magnitude determines which planetary satellites can be observed through the telescope. This discussion was much appreciated by the reviewer.

As you might expect, each chapter discusses a separate Solar System object, though comets and asteroids are considered to be a single entity. Each chapter contains very useful information on the object: tables predicting future oppositions, favourable elongations, etc. from the present to 2016 and beyond, in some cases. The tables alone make the book worth the cost, as it will make a handy reference guide for years to come.

As much as I enjoyed flipping through the pages of *Solar System Observer's Guide*, I did notice a few shortcomings. Most notably the book was published before the International Astronomical Union made its decision to demote Pluto to the status of a dwarf planet. Here the author is a victim of bad timing, which, unfortunately, dates the book. In the chapter on Mars, the author describes surface features without including a proper map divided into longitude and latitude grids for reference purposes. In the case of Jupiter, the nomenclature for cloud features (festoons, rifts, bars, ovals, etc.) is described in the text without any pictorial reference, which makes identification of such features more difficult. The inclusion of sample observing templates, or at least where to find them on the Web, would have been a useful addition. I also feel that an expanded topic dedicated to atmospheric seeing conditions is a must in any planetary observing book. In fairness, the

author did have a few paragraphs about the subject, but it was not enough. As every experienced planetary observer knows, it is not the telescope that is the limiting factor in observing the planets, but our atmosphere. Some general guidelines, such as how to assess the seeing conditions quickly by evaluating the amount of star scintillation and tips on locating one's observing site away from heat currents rising from roof tops and concrete slabs, could have been included. All are valuable tricks of the trade for optimum observing experiences. Other important rules of thumb such as allowing the telescope to cool to the outdoor temperature and maintaining proper collimation are equally as important, but were somehow missed.

Despite its shortcomings, *Solar System Observer's Guide* is a very attractive and well-illustrated book in an easy-to-read format. It contains sufficient useful information without too much technical jargon to confuse the beginner. More importantly, I believe it allows the novice to cultivate an appreciation for planetary study. Should it be the sole source for planetary observing in your library? I would have to say no, as there are more comprehensive books out there, but it does earn a place on my bookshelf to supplement my collection.

— MICHAEL KARAKAS

*Mike Karakas is an architectural technologist by profession and planetary observing enthusiast by choice. He disregards the comments from his fellow astronomy friends who say that planets are light pollution, and enjoys both sketching and imaging planets from his backyard in Winnipeg, Manitoba. ●*

---

## Pen & Pixel

---



Mike Karakas of the Winnipeg Centre captured Saturn in spectacular fashion using a Celestron C8 Ultima and a ToUcamPro II Webcam. This image, from October 25, 2004, is composed of 500 frames stacked and processed with Registax.

# Astrocryptic

by Curt Nason, Moncton Centre

## ACROSS

1. A poor eyepiece to probe Titan with (7)
5. ALPO undergoes reorganization before starting routine scope alignment (5)
8. Early arrangement of stars pertaining to Vega's home (5)
9. False double star exploded capitol (7)
10. It's not odd to face the beginning of tomorrow at the black hole's horizon (5)
11. Apochromatic objective of a journey to the French capital of Tunisia (7)
12. He made a reflector from two canes in a mix of glass (5,6)
17. Bug the Greek warmonger about a supergiant (7)
19. I left the Trifid in confusion after performing the method of alignment (5)
20. Air is sucked back around beryllium in Tunguska locale (7)
21. Ms. Mattei or Mr. Oort with an alien (5)
22. Greek island where Collinder briefly spent Messier's summer (5)
23. Noisy CD spins with an orbital lap period (7)

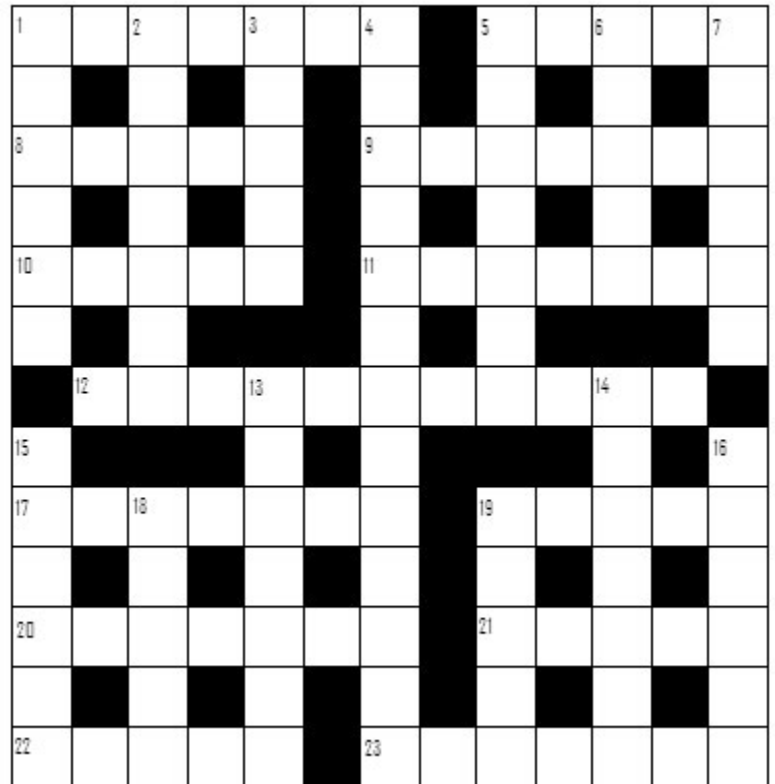

## DOWN

1. Comet predictor with a passageway beside hotel (6)
2. Noted astronomy town with rare sky conditions (7)
3. Perturb from orbit with endless ejecta (5)
4. Indiscriminately roasting hosts of meteors (8,5)
5. Lab dish gives conflicting directions to prairie comet finder (7)
6. Lite version of our galaxy group? (5)
7. Make a connection within craters formed before late bombardment (6)
13. Skylights flashing across a Centaur or aerolite (7)
14. Autumn meteor blamed for smashing in 1 door (7)
15. Scrape off rust accumulated over a very great distance (6)
16. Steady universe causes radio noise (6)
18. Data arrangement placed on the mountain in the sky (5)
19. Spicy condiment from Io around Jupiter between the start of day and night (5)

*Curt Nason is a Health Physicist at New Brunswick's largest nuclear facility. If you are puzzled by the Astrocryptic, contact him at [nasonc@nbnet.nb.ca](mailto:nasonc@nbnet.nb.ca).*

# THE ROYAL ASTRONOMICAL SOCIETY OF CANADA

## NATIONAL OFFICERS AND COUNCIL FOR 2006-2007/CONSEIL ET ADMINISTRATEURS NATIONAUX

<b>Honorary President</b>	Robert Garrison, Ph.D., Toronto
<b>President</b>	Scott Young, B.Sc., Winnipeg
<b>1st Vice-President</b>	Dave Lane, Halifax
<b>2nd Vice-President</b>	Mary Lou Whitehorne, Halifax
<b>Secretary</b>	Stan Runge, Winnipeg
<b>Treasurer</b>	David Clark, London
<b>Recorder</b>	James Edgar, Regina
<b>Librarian</b>	Robert Garrison, Ph.D., Toronto
<b>Past Presidents</b>	Peter Jedicke, M.A. London and Rajiv Gupta, Ph.D., Vancouver
<b>Editor of <i>Journal</i></b>	Jay Anderson, B.Sc., MNRM, Winnipeg
<b>Editor of <i>Observer's Handbook</i></b>	Patrick Kelly, M.Sc., Halifax
<b>Editor of <i>The Beginner's Observing Guide</i></b>	Leo Enright, B.A., Kingston
<b>Editor of <i>Observer's Calendar</i></b>	Dave Lane, Halifax
<b>Executive Secretary</b>	Bonnie Bird, M.L.Sc., 136 Dupont Street, Toronto ON M5R 1V2 Telephone: (416) 924-7973

---

## CENTRE ADDRESSES/ADRESSES DES CENTRES

The most current contact information and Web site addresses for all Centres are available at the Society's Web site: [www.rasc.ca](http://www.rasc.ca)

### **Belleville Centre**

c/o Greg Lisk, 11 Robert Dr, Trenton ON K8V 6P2

### **Calgary Centre**

c/o Telus World of Science, PO Box 2100 Stn M Location 73,  
Calgary AB T2P 2M5

### **Charlottetown Centre**

PO Box 1734, Charlottetown PE C1A 7N4

### **Edmonton Centre**

c/o Telus World of Science, 11211 142 St., Edmonton AB T5M 4A1

### **Halifax Centre**

PO Box 31011, Halifax NS B3K 5T9

### **Hamilton Centre**

576 - Concession 7 E, PO Box 1223, Waterdown ON L0R 2H0

### **Kingston Centre**

PO Box 1793, Kingston ON K7L 5J6

### **Kitchener-Waterloo Centre**

460 Sandbanks Cres, Waterloo ON N2V 2J2

### **London Centre**

PO Box 842 Stn B, London ON N6A 4Z3

### **Centre francophone de Montréal**

C P 206, Station St-Michel, Montréal QC H2A 3L9

### **Mississauga Centre**

c/o Randy Attwood, 4348 Dallas Ct, Mississauga ON L4W 4G7

### **Moncton Centre**

c/o Dr. Francis LeBlanc, Département de Physique et Astronomie,  
Université de Moncton, Moncton NB E1A 3E9

### **Montreal Centre**

PO Box 1752 Stn B, Montreal QC H3B 3L3

### **Niagara Centre**

PO Box 4040, St. Catharines ON L2R 7S3

### **Okanagan Centre**

PO Box 20019 TCM, Kelowna BC V1Y 9H2

### **Ottawa Centre**

1363 Woodroffe Ave, PO Box 33012, Ottawa ON K2C 3Y9

### **Prince George Centre**

7365 Tedford Rd, Prince George BC V2N 6S2

### **Québec Centre**

2000 Boul Montmorency, Québec QC G1J 5E7

### **Regina Centre**

PO Box 20014, Regina SK S4P 4J7

### **St. John's Centre**

c/o Randy Dodge, 206 Frecker Dr, St. John's NL A1E 5H9

### **Sarnia Centre**

c/o Marty Cogswell, 6723 Pheasant Lane RR 1, Camlachie ON N0N 1E0

### **Saskatoon Centre**

PO Box 317 RPO University, Saskatoon SK S7N 4J8

### **Thunder Bay Centre**

286 Trinity Cres, Thunder Bay ON P7C 5V6

### **Toronto Centre**

c/o Ontario Science Centre, 770 Don Mills Rd, North York ON M3C 1T3

### **Vancouver Centre**

1100 Chestnut St, Vancouver BC V6J 3J9

### **Victoria Centre**

333 - 1900 Mayfair Dr, Victoria BC V8P 1P9

### **Windsor Centre**

2831 Alexandra Ave, Windsor ON N9E 2J8

### **Winnipeg Centre**

PO Box 2694, Winnipeg MB R3C 4B3

---

# Publications and Products of

The Royal Astronomical Society of Canada

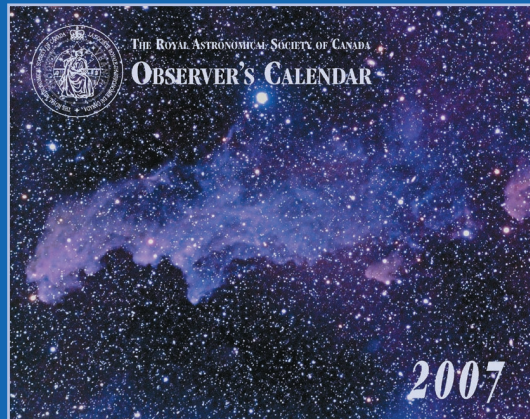

## Observer's Calendar — 2007

The award-winning RASC Observer's Calendar is your annual guide

Created by the Royal Astronomical Society of Canada and richly illustrated by photographs from leading amateur astronomers, the calendar pages are packed with detailed information including major lunar and planetary conjunctions, meteor showers, eclipses, lunar phases, and daily Moonrise and Moonset times. Canadian and U.S. holidays are highlighted. Perfect for home, office, or observatory.

Individual Order Prices:

\$16.95 Cdn/ \$13.95 US

RASC members receive a \$3.00 discount  
Shipping and handling not included.

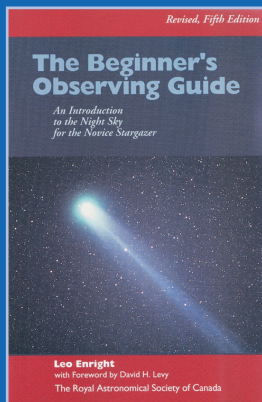

## The Beginner's Observing Guide

Extensively revised and now in its fifth edition, *The Beginner's Observing Guide* is for a variety of observers, from the beginner with no experience to the intermediate who would appreciate the clear, helpful guidance here available on an expanded variety of topics: constellations, bright stars, the motions of the heavens, lunar features, the aurora, and the zodiacal light. New sections include: lunar and planetary data through 2010, variable-star observing, telescope information, beginning astrophotography, a non-technical glossary of astronomical terms, and directions for building a properly scaled model of the solar system.

Written by astronomy author and educator, Leo Enright; 200 pages, 6 colour star maps, 16 photographs, otabinding.

Price: \$19.95 plus shipping & handling

## Skyways: Astronomy Handbook for Teachers

Teaching Astronomy? Skyways Makes it Easy!

Written by a Canadian for Canadian teachers and astronomy educators, *Skyways* is Canadian curriculum-specific; pre-tested by Canadian teachers; hands-on; interactive; geared for upper elementary, middle school, and junior-high grades; fun and easy to use; cost-effective.

*Skyways* is complete with conceptual background; teacher information; student worksheets; resource lists; Canadian contributions to astronomy section; FAQs; and more. Written by Canadian author and RASC member, Mary Lou Whitehorne.

Price: \$16.95 Cdn (members); \$19.95 Cdn (non-members)  
(plus shipping and handling; add GST for Canadian orders)

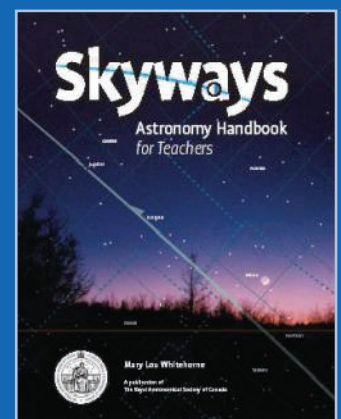

## Shop On-Line at [www.store.rasc.ca](http://www.store.rasc.ca)

Send cheque or money order to: RASC, 136 Dupont St, Toronto ON M5R 1V2 Canada  
Please allow 6-8 weeks for delivery. Orders outside Canada please remit in US Funds.

Major credit cards accepted. Call the National Office toll-free at 1-888-924-7272 to place your order.  
(These products may also be available directly from your local Centre)